

Round 1

Round 2

Round 3

Round 4

Round 5

Round 6

Round 7

Round 8

Round 9

Round 10

Bonus Round

# Welcome to Quarantine Trivia IX!



It's been a pretty lousy week, but some good things did happen (and we're not being ironic here):

Welcome to  
Quarantine Trivia  
IX!

Round 1

Round 2

Round 3

Round 4

Round 5

Round 6

Round 7

Round 8

Round 9

Round 10

Bonus Round

It's been a pretty lousy week, but some good things did happen (and we're not being ironic here):

Jyoti Kumari, a fifteen year old girl who lives in India, rode her injured father 700 miles from New Dehli back home on the back of her bicycle. This earned her the nickname "Jyoti the Lionhearted".



Round 1

Round 2

Round 3

Round 4

Round 5

Round 6

Round 7

Round 8

Round 9

Round 10

Bonus Round

It's been a pretty lousy week, but some good things did happen (and we're not being ironic here):

British chef Ethan Rogers has created a six-foot-long “Back to Work Baguette”, the sandwich for social distancers.



Welcome to  
Quarantine Trivia  
IX!

Round 1

Round 2

Round 3

Round 4

Round 5

Round 6

Round 7

Round 8

Round 9

Round 10

Bonus Round

It's been a pretty lousy week, but some good things did happen (and we're not being ironic here):

With today's launch of SpaceX's Falcon 9, the U.S. resumed human spaceflight.



Welcome to  
Quarantine Trivia  
IX!

Round 1

Round 2

Round 3

Round 4

Round 5

Round 6

Round 7

Round 8

Round 9

Round 10

Bonus Round

# Categories

Welcome to  
Quarantine Trivia  
IX!

This week, you'll be answering questions in the following categories:

1. Aviation
2. Ireland
3. Colonial America
4. Famous Ships and Boats
5. Foreign Words and Phrases
6. Birds
7. Native Americans
8. The home of ...
9. Wonders of Engineering
10. Washington, D.C.

Round 1

Round 2

Round 3

Round 4

Round 5

Round 6

Round 7

Round 8

Round 9

Round 10

Bonus Round

Round 1

Round 2

Round 3

Round 4

Round 5

Round 6

Round 7

Round 8

Round 9

Round 10

Bonus Round

Good luck everyone! And have fun!

Round 1

Q1

Q2

Q3

Q4

Q5

Q6

Q7

Q8

Q9

Q10

Answers

Round 2

Round 3

Round 4

Round 5

Round 6

Round 7

Round 8

Round 9

Round 10

Bonus Round

# Round 1

## Aviation

Please mute yourselves!



# Round 1 — Aviation — Question 1

Welcome to  
Quarantine Trivia  
IX!

## Question

In the U.S., what is the minimum age at which you can be granted your private pilot's license for powered aircraft?

Round 1

Q1

Q2

Q3

Q4

Q5

Q6

Q7

Q8

Q9

Q10

Answers

Round 2

Round 3

Round 4

Round 5

Round 6

Round 7

Round 8

Round 9

Round 10

Bonus Round

# Round 1 — Aviation — Question 2

Welcome to  
Quarantine Trivia  
IX!

## Question

Due to the shortage of aluminum during WWII, the Hughes Aircraft Company built an almost entirely wooden aircraft prototype, the H-4 Hercules. What nickname was it better known by?

Round 1

Q1

Q2

Q3

Q4

Q5

Q6

Q7

Q8

Q9

Q10

Answers

Round 2

Round 3

Round 4

Round 5

Round 6

Round 7

Round 8

Round 9

Round 10

Bonus Round

# Round 1 — Aviation — Question 3

Welcome to  
Quarantine Trivia  
IX!

## Question

In the aviation world, what does “FAA” stand for?

Round 1

Q1

Q2

**Q3**

Q4

Q5

Q6

Q7

Q8

Q9

Q10

Answers

Round 2

Round 3

Round 4

Round 5

Round 6

Round 7

Round 8

Round 9

Round 10

Bonus Round

# Round 1 — Aviation — Question 4

Welcome to  
Quarantine Trivia  
IX!

## Question

Give the aviation names of the three dimensions that an aircraft can rotate in, as pictured here. (You only need the names; you don't need to know which is which.)

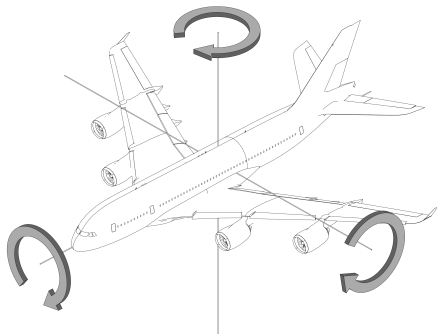

Round 1

Q1

Q2

Q3

**Q4**

Q5

Q6

Q7

Q8

Q9

Q10

Answers

Round 2

Round 3

Round 4

Round 5

Round 6

Round 7

Round 8

Round 9

Round 10

Bonus Round

# Round 1 — Aviation — Question 5

Welcome to  
Quarantine Trivia  
IX!

## Question

What was the name of the plane Charles Lindbergh flew on the first nonstop trans-Atlantic flight?

Round 1

Q1

Q2

Q3

Q4

**Q5**

Q6

Q7

Q8

Q9

Q10

Answers

Round 2

Round 3

Round 4

Round 5

Round 6

Round 7

Round 8

Round 9

Round 10

Bonus Round

# Round 1 — Aviation — Question 6

Welcome to  
Quarantine Trivia  
IX!

## Question

In what year did the Wright Brothers complete their famous first flight of a heavier-than-air, powered aircraft?

Round 1

Q1

Q2

Q3

Q4

Q5

**Q6**

Q7

Q8

Q9

Q10

Answers

Round 2

Round 3

Round 4

Round 5

Round 6

Round 7

Round 8

Round 9

Round 10

Bonus Round

# Round 1 — Aviation — Question 7

Welcome to  
Quarantine Trivia  
IX!

## Question

What is the name  
of the WWII-era  
fighter aircraft  
pictured here?



Round 1

Q1

Q2

Q3

Q4

Q5

Q6

Q7

Q8

Q9

Q10

Answers

Round 2

Round 3

Round 4

Round 5

Round 6

Round 7

Round 8

Round 9

Round 10

Bonus Round

# Round 1 — Aviation — Question 8

Welcome to  
Quarantine Trivia  
IX!

## Question

Whether measured by fleet size or number of passengers carried annually, which airline is the largest airline in the world?

Round 1

Q1

Q2

Q3

Q4

Q5

Q6

Q7

**Q8**

Q9

Q10

Answers

Round 2

Round 3

Round 4

Round 5

Round 6

Round 7

Round 8

Round 9

Round 10

Bonus Round



# Round 1 — Aviation — Question 9

Welcome to  
Quarantine Trivia  
IX!

## Question

What was the name of the experimental airplane in which Chuck Yeager first broke the sound barrier?

Round 1

Q1

Q2

Q3

Q4

Q5

Q6

Q7

Q8

**Q9**

Q10

Answers

Round 2

Round 3

Round 4

Round 5

Round 6

Round 7

Round 8

Round 9

Round 10

Bonus Round

# Round 1 — Aviation — Question 10

Welcome to  
Quarantine Trivia  
IX!

## Question

This isn't Boeing's logo; it's the logo of the company that merged with Boeing in 1997, whose logo Boeing modified slightly before adopting. Which (former) company's logo is it?

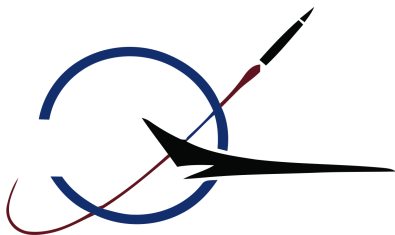

Round 1

Q1

Q2

Q3

Q4

Q5

Q6

Q7

Q8

Q9

**Q10**

Answers

Round 2

Round 3

Round 4

Round 5

Round 6

Round 7

Round 8

Round 9

Round 10

Bonus Round

Round 1

Q1

Q2

Q3

Q4

Q5

Q6

Q7

Q8

Q9

Q10

Answers

Round 2

Round 3

Round 4

Round 5

Round 6

Round 7

Round 8

Round 9

Round 10

Bonus Round

# Round 1

## Answers

Unmute yourselves!

# Round 1 — Aviation — Answer 1

Welcome to  
Quarantine Trivia  
IX!

## Question

In the U.S., what is the minimum age at which you can be granted your private pilot's license for powered aircraft?

Round 1

Q1

Q2

Q3

Q4

Q5

Q6

Q7

Q8

Q9

Q10

Answers

Round 2

Round 3

Round 4

Round 5

Round 6

Round 7

Round 8

Round 9

Round 10

Bonus Round

# Round 1 — Aviation — Answer 1

Welcome to  
Quarantine Trivia  
IX!

## Question

In the U.S., what is the minimum age at which you can be granted your private pilot's license for powered aircraft?

## Answer

17



Round 1

Q1

Q2

Q3

Q4

Q5

Q6

Q7

Q8

Q9

Q10

Answers

Round 2

Round 3

Round 4

Round 5

Round 6

Round 7

Round 8

Round 9

Round 10

Bonus Round

# Round 1 — Aviation — Answer 2

Welcome to  
Quarantine Trivia  
IX!

## Question

Due to the shortage of aluminum during WWII, the Hughes Aircraft Company built an almost entirely wooden aircraft prototype, the H-4 Hercules. What nickname was it better known by?

Round 1

Q1

Q2

Q3

Q4

Q5

Q6

Q7

Q8

Q9

Q10

Answers

Round 2

Round 3

Round 4

Round 5

Round 6

Round 7

Round 8

Round 9

Round 10

Bonus Round

# Round 1 — Aviation — Answer 2

Welcome to  
Quarantine Trivia  
IX!

## Question

Due to the shortage of aluminum during WWII, the Hughes Aircraft Company built an almost entirely wooden aircraft prototype, the H-4 Hercules. What nickname was it better known by?

## Answer

*The Spruce Goose*

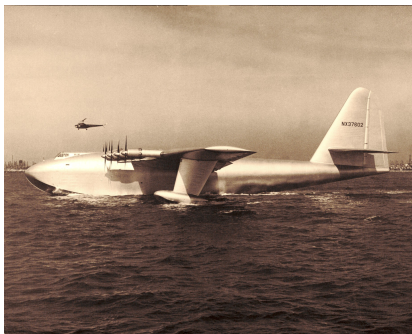

Round 1

Q1

Q2

Q3

Q4

Q5

Q6

Q7

Q8

Q9

Q10

Answers

Round 2

Round 3

Round 4

Round 5

Round 6

Round 7

Round 8

Round 9

Round 10

Bonus Round

# Round 1 — Aviation — Answer 3

Welcome to  
Quarantine Trivia  
IX!

## Question

In the aviation world, what does “FAA” stand for?

Round 1

Q1

Q2

Q3

Q4

Q5

Q6

Q7

Q8

Q9

Q10

Answers

Round 2

Round 3

Round 4

Round 5

Round 6

Round 7

Round 8

Round 9

Round 10

Bonus Round



# Round 1 — Aviation — Answer 3

Welcome to  
Quarantine Trivia  
IX!

## Question

In the aviation world, what does “FAA” stand for?

## Answer

Federal Aviation  
Administration



Round 1

Q1

Q2

Q3

Q4

Q5

Q6

Q7

Q8

Q9

Q10

Answers

Round 2

Round 3

Round 4

Round 5

Round 6

Round 7

Round 8

Round 9

Round 10

Bonus Round

# Round 1 — Aviation — Answer 4

Welcome to  
Quarantine Trivia  
IX!

## Question

Give the aviation names of the three dimensions that an aircraft can rotate in, as pictured here. (You only need the names; you don't need to know which is which.)

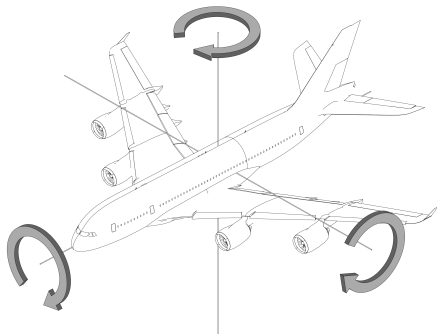

Round 1

Q1

Q2

Q3

Q4

Q5

Q6

Q7

Q8

Q9

Q10

Answers

Round 2

Round 3

Round 4

Round 5

Round 6

Round 7

Round 8

Round 9

Round 10

Bonus Round

# Round 1 — Aviation — Answer 4

Welcome to  
Quarantine Trivia  
IX!

## Question

Give the aviation names of the three dimensions that an aircraft can rotate in, as pictured here. (You only need the names; you don't need to know which is which.)

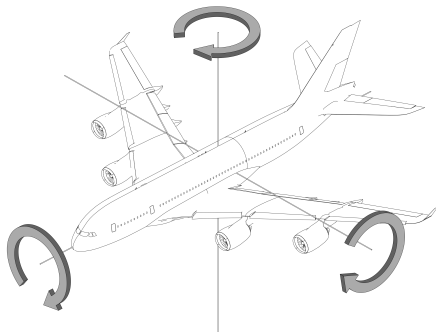

## Answer

Roll, pitch, and  
yaw

Round 1

Q1

Q2

Q3

Q4

Q5

Q6

Q7

Q8

Q9

Q10

Answers

Round 2

Round 3

Round 4

Round 5

Round 6

Round 7

Round 8

Round 9

Round 10

Bonus Round

# Round 1 — Aviation — Answer 5

Welcome to  
Quarantine Trivia  
IX!

## Question

What was the name of the plane Charles Lindbergh flew on the first nonstop trans-Atlantic flight?

Round 1

Q1

Q2

Q3

Q4

Q5

Q6

Q7

Q8

Q9

Q10

Answers

Round 2

Round 3

Round 4

Round 5

Round 6

Round 7

Round 8

Round 9

Round 10

Bonus Round

# Round 1 — Aviation — Answer 5

Welcome to  
Quarantine Trivia  
IX!

## Question

What was the name of the plane Charles Lindbergh flew on the first nonstop trans-Atlantic flight?

## Answer

*The Spirit of St. Louis*



Round 1

Q1

Q2

Q3

Q4

Q5

Q6

Q7

Q8

Q9

Q10

Answers

Round 2

Round 3

Round 4

Round 5

Round 6

Round 7

Round 8

Round 9

Round 10

Bonus Round

# Round 1 — Aviation — Answer 6

Welcome to  
Quarantine Trivia  
IX!

## Question

In what year did the Wright Brothers complete their famous first flight of a heavier-than-air, powered aircraft?

Round 1

Q1

Q2

Q3

Q4

Q5

Q6

Q7

Q8

Q9

Q10

Answers

Round 2

Round 3

Round 4

Round 5

Round 6

Round 7

Round 8

Round 9

Round 10

Bonus Round

# Round 1 — Aviation — Answer 6

Welcome to  
Quarantine Trivia  
IX!

## Question

In what year did the Wright Brothers complete their famous first flight of a heavier-than-air, powered aircraft?

## Answer

1903

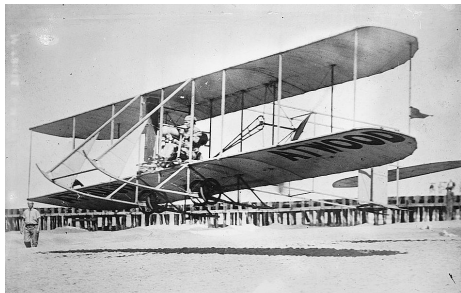

Round 1

Q1

Q2

Q3

Q4

Q5

Q6

Q7

Q8

Q9

Q10

Answers

Round 2

Round 3

Round 4

Round 5

Round 6

Round 7

Round 8

Round 9

Round 10

Bonus Round

# Round 1 — Aviation — Answer 7

Welcome to  
Quarantine Trivia  
IX!

## Question

What is the name  
of the WWII-era  
fighter aircraft  
pictured here?



Round 1

Q1

Q2

Q3

Q4

Q5

Q6

Q7

Q8

Q9

Q10

Answers

Round 2

Round 3

Round 4

Round 5

Round 6

Round 7

Round 8

Round 9

Round 10

Bonus Round



# Round 1 — Aviation — Answer 7

Welcome to  
Quarantine Trivia  
IX!

## Question

What is the name  
of the WWII-era  
fighter aircraft  
pictured here?



## Answer

Spitfire /  
Submarine Spitfire

Round 1

Q1

Q2

Q3

Q4

Q5

Q6

Q7

Q8

Q9

Q10

Answers

Round 2

Round 3

Round 4

Round 5

Round 6

Round 7

Round 8

Round 9

Round 10

Bonus Round

# Round 1 — Aviation — Answer 8

Welcome to  
Quarantine Trivia  
IX!

## Question

Whether measured by fleet size or number of passengers carried annually, which airline is the largest airline in the world?

Round 1

Q1

Q2

Q3

Q4

Q5

Q6

Q7

Q8

Q9

Q10

Answers

Round 2

Round 3

Round 4

Round 5

Round 6

Round 7

Round 8

Round 9

Round 10

Bonus Round

# Round 1 — Aviation — Answer 8

Welcome to  
Quarantine Trivia  
IX!

## Question

Whether measured by fleet size or number of passengers carried annually, which airline is the largest airline in the world?

## Answer

American Airlines



Round 1

Q1

Q2

Q3

Q4

Q5

Q6

Q7

Q8

Q9

Q10

Answers

Round 2

Round 3

Round 4

Round 5

Round 6

Round 7

Round 8

Round 9

Round 10

Bonus Round

# Round 1 — Aviation — Answer 9

Welcome to  
Quarantine Trivia  
IX!

## Question

What was the name of the experimental airplane in which Chuck Yeager first broke the sound barrier?

Round 1

Q1

Q2

Q3

Q4

Q5

Q6

Q7

Q8

Q9

Q10

Answers

Round 2

Round 3

Round 4

Round 5

Round 6

Round 7

Round 8

Round 9

Round 10

Bonus Round

# Round 1 — Aviation — Answer 9

Welcome to  
Quarantine Trivia  
IX!

## Question

What was the name of the experimental airplane in which Chuck Yeager first broke the sound barrier?

## Answer

Bell X-1 /  
Glamorous  
Glennis



Round 1

Q1

Q2

Q3

Q4

Q5

Q6

Q7

Q8

Q9

Q10

Answers

Round 2

Round 3

Round 4

Round 5

Round 6

Round 7

Round 8

Round 9

Round 10

Bonus Round

# Round 1 — Aviation — Answer 10

Welcome to  
Quarantine Trivia  
IX!

## Question

This isn't Boeing's logo; it's the logo of the company that merged with Boeing in 1997, whose logo Boeing modified slightly before adopting. Which (former) company's logo is it?

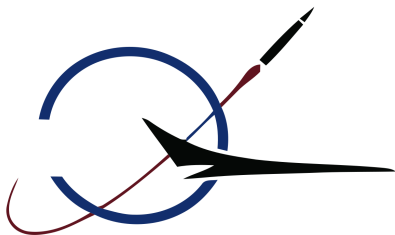

Round 1

Q1

Q2

Q3

Q4

Q5

Q6

Q7

Q8

Q9

Q10

Answers

Round 2

Round 3

Round 4

Round 5

Round 6

Round 7

Round 8

Round 9

Round 10

Bonus Round

# Round 1 — Aviation — Answer 10

Welcome to  
Quarantine Trivia  
IX!

## Question

This isn't Boeing's logo; it's the logo of the company that merged with Boeing in 1997, whose logo Boeing modified slightly before adopting. Which (former) company's logo is it?

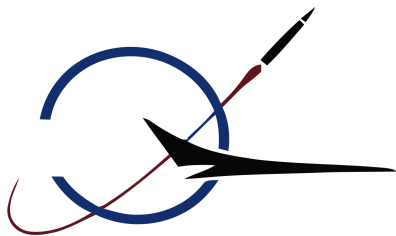

## Answer

McDonnell  
Douglas

Round 1

Q1

Q2

Q3

Q4

Q5

Q6

Q7

Q8

Q9

Q10

Answers

Round 2

Round 3

Round 4

Round 5

Round 6

Round 7

Round 8

Round 9

Round 10

Bonus Round

Round 1

**Round 2**

Q1

Q2

Q3

Q4

Q5

Q6

Q7

Q8

Q9

Q10

Answers

Round 3

Round 4

Round 5

Round 6

Round 7

Round 8

Round 9

Round 10

Bonus Round

## Round 2

### Ireland

Please mute yourselves!



# Round 2 — Ireland — Question 1

Welcome to  
Quarantine Trivia  
IX!

## Question

People bend over backwards to visit this tourist attraction in Ireland and then they presumably gab about their visit. What is the tourist attraction?

Round 1

Round 2

Q1

Q2

Q3

Q4

Q5

Q6

Q7

Q8

Q9

Q10

Answers

Round 3

Round 4

Round 5

Round 6

Round 7

Round 8

Round 9

Round 10

Bonus Round

# Round 2 — Ireland — Question 2

Welcome to  
Quarantine Trivia  
IX!

## Question

How many counties are there in the Republic of Ireland?

Round 1

Round 2

Q1

**Q2**

Q3

Q4

Q5

Q6

Q7

Q8

Q9

Q10

Answers

Round 3

Round 4

Round 5

Round 6

Round 7

Round 8

Round 9

Round 10

Bonus Round

# Round 2 — Ireland — Question 3

Welcome to  
Quarantine Trivia  
IX!

## Question

What is the name of the famous Irish crystal that takes its name from the city in which it is produced?

Round 1

Round 2

Q1

Q2

**Q3**

Q4

Q5

Q6

Q7

Q8

Q9

Q10

Answers

Round 3

Round 4

Round 5

Round 6

Round 7

Round 8

Round 9

Round 10

Bonus Round

# Round 2 — Ireland — Question 4

Welcome to  
Quarantine Trivia  
IX!

## Question

What is the name of the northernmost peninsula in County Kerry, known for its stunningly beautiful scenery?

Round 1

Round 2

Q1

Q2

Q3

**Q4**

Q5

Q6

Q7

Q8

Q9

Q10

Answers

Round 3

Round 4

Round 5

Round 6

Round 7

Round 8

Round 9

Round 10

Bonus Round

# Round 2 — Ireland — Question 5

Welcome to  
Quarantine Trivia  
IX!

## Question

By population, what is the second largest city in Ireland?

Round 1

Round 2

Q1

Q2

Q3

Q4

**Q5**

Q6

Q7

Q8

Q9

Q10

Answers

Round 3

Round 4

Round 5

Round 6

Round 7

Round 8

Round 9

Round 10

Bonus Round

# Round 2 — Ireland — Question 6

Welcome to  
Quarantine Trivia  
IX!

## Question

In what year did the Irish win their independence from Great Britain?

Round 1

Round 2

Q1

Q2

Q3

Q4

Q5

**Q6**

Q7

Q8

Q9

Q10

Answers

Round 3

Round 4

Round 5

Round 6

Round 7

Round 8

Round 9

Round 10

Bonus Round

# Round 2 — Ireland — Question 7

Welcome to  
Quarantine Trivia  
IX!

## Question

What is the name of the Yeats poem that includes the repeated line, “A terrible beauty is born”?

Round 1

Round 2

Q1

Q2

Q3

Q4

Q5

Q6

**Q7**

Q8

Q9

Q10

Answers

Round 3

Round 4

Round 5

Round 6

Round 7

Round 8

Round 9

Round 10

Bonus Round

# Round 2 — Ireland — Question 8

Welcome to  
Quarantine Trivia  
IX!

## Question

What famous oratorio, performed annually around the world to this day, had its debut at The Great Music Hall in Dublin during lent in 1742?

Round 1

Round 2

Q1

Q2

Q3

Q4

Q5

Q6

Q7

**Q8**

Q9

Q10

Answers

Round 3

Round 4

Round 5

Round 6

Round 7

Round 8

Round 9

Round 10

Bonus Round



# Round 2 — Ireland — Question 9

Welcome to  
Quarantine Trivia  
IX!

## Question

What was Yogi Berra's reported response to being told that Robert Briscoe, the Lord Mayor of Dublin, was Jewish?

Round 1

Round 2

Q1

Q2

Q3

Q4

Q5

Q6

Q7

Q8

**Q9**

Q10

Answers

Round 3

Round 4

Round 5

Round 6

Round 7

Round 8

Round 9

Round 10

Bonus Round

# Round 2 — Ireland — Question 10

Welcome to  
Quarantine Trivia  
IX!

## Question

According to legend, what animal did St. Patrick drive out of Ireland?

Round 1

Round 2

Q1

Q2

Q3

Q4

Q5

Q6

Q7

Q8

Q9

**Q10**

Answers

Round 3

Round 4

Round 5

Round 6

Round 7

Round 8

Round 9

Round 10

Bonus Round

Round 1

Round 2

Q1

Q2

Q3

Q4

Q5

Q6

Q7

Q8

Q9

Q10

Answers

Round 3

Round 4

Round 5

Round 6

Round 7

Round 8

Round 9

Round 10

Bonus Round

## Round 2

### Answers

Unmute yourselves!

# Round 2 — Ireland — Answer 1

Welcome to  
Quarantine Trivia  
IX!

## Question

People bend over backwards to visit this tourist attraction in Ireland and then they presumably gab about their visit. What is the tourist attraction?

Round 1

Round 2

Q1

Q2

Q3

Q4

Q5

Q6

Q7

Q8

Q9

Q10

Answers

Round 3

Round 4

Round 5

Round 6

Round 7

Round 8

Round 9

Round 10

Bonus Round

# Round 2 — Ireland — Answer 1

Welcome to  
Quarantine Trivia  
IX!

## Question

People bend over backwards to visit this tourist attraction in Ireland and then they presumably gab about their visit. What is the tourist attraction?

## Answer

The Blarney Stone



Round 1

Round 2

Q1

Q2

Q3

Q4

Q5

Q6

Q7

Q8

Q9

Q10

Answers

Round 3

Round 4

Round 5

Round 6

Round 7

Round 8

Round 9

Round 10

Bonus Round

# Round 2 — Ireland — Answer 2

Welcome to  
Quarantine Trivia  
IX!

## Question

How many counties are there in the Republic of Ireland?

Round 1

Round 2

Q1

Q2

Q3

Q4

Q5

Q6

Q7

Q8

Q9

Q10

Answers

Round 3

Round 4

Round 5

Round 6

Round 7

Round 8

Round 9

Round 10

Bonus Round

# Round 2 — Ireland — Answer 2

Welcome to  
Quarantine Trivia  
IX!

## Question

How many counties are there in the Republic of Ireland?

## Answer

26

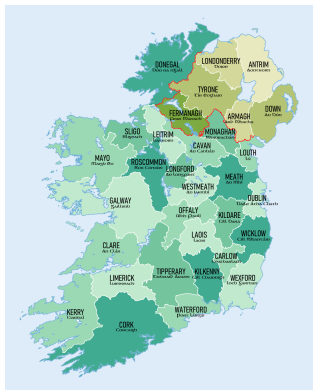

Round 1

Round 2

Q1

Q2

Q3

Q4

Q5

Q6

Q7

Q8

Q9

Q10

Answers

Round 3

Round 4

Round 5

Round 6

Round 7

Round 8

Round 9

Round 10

Bonus Round

# Round 2 — Ireland — Answer 3

Welcome to  
Quarantine Trivia  
IX!

## Question

What is the name of the famous Irish crystal that takes its name from the city in which it is produced?

Round 1

Round 2

Q1

Q2

Q3

Q4

Q5

Q6

Q7

Q8

Q9

Q10

Answers

Round 3

Round 4

Round 5

Round 6

Round 7

Round 8

Round 9

Round 10

Bonus Round



## Round 2 — Ireland — Answer 3

Welcome to  
Quarantine Trivia  
IX!

### Question

What is the name of the famous Irish crystal that takes its name from the city in which it is produced?

### Answer

Waterford



Round 1

Round 2

Q1

Q2

Q3

Q4

Q5

Q6

Q7

Q8

Q9

Q10

Answers

Round 3

Round 4

Round 5

Round 6

Round 7

Round 8

Round 9

Round 10

Bonus Round

# Round 2 — Ireland — Answer 4

Welcome to  
Quarantine Trivia  
IX!

## Question

What is the name of the northernmost peninsula in County Kerry, known for its stunningly beautiful scenery?

Round 1

Round 2

Q1

Q2

Q3

Q4

Q5

Q6

Q7

Q8

Q9

Q10

Answers

Round 3

Round 4

Round 5

Round 6

Round 7

Round 8

Round 9

Round 10

Bonus Round

## Round 2 — Ireland — Answer 4

Welcome to  
Quarantine Trivia  
IX!

### Question

What is the name of the northernmost peninsula in County Kerry, known for its stunningly beautiful scenery?

### Answer

The Dingle  
Peninsula / The  
Dingle



Round 1

Round 2

Q1

Q2

Q3

Q4

Q5

Q6

Q7

Q8

Q9

Q10

Answers

Round 3

Round 4

Round 5

Round 6

Round 7

Round 8

Round 9

Round 10

Bonus Round

# Round 2 — Ireland — Answer 5

Welcome to  
Quarantine Trivia  
IX!

## Question

By population, what is the second largest city in Ireland?

Round 1

Round 2

Q1

Q2

Q3

Q4

Q5

Q6

Q7

Q8

Q9

Q10

Answers

Round 3

Round 4

Round 5

Round 6

Round 7

Round 8

Round 9

Round 10

Bonus Round

# Round 2 — Ireland — Answer 5

Welcome to  
Quarantine Trivia  
IX!

## Question

By population, what is the second largest city in Ireland?

## Answer

Cork (Republic of  
Ireland) or Belfast  
(all of Ireland)



Round 1

Round 2

Q1

Q2

Q3

Q4

Q5

Q6

Q7

Q8

Q9

Q10

Answers

Round 3

Round 4

Round 5

Round 6

Round 7

Round 8

Round 9

Round 10

Bonus Round

# Round 2 — Ireland — Answer 6

Welcome to  
Quarantine Trivia  
IX!

## Question

In what year did the Irish win their independence from Great Britain?

Round 1

Round 2

Q1

Q2

Q3

Q4

Q5

Q6

Q7

Q8

Q9

Q10

Answers

Round 3

Round 4

Round 5

Round 6

Round 7

Round 8

Round 9

Round 10

Bonus Round

# Round 2 — Ireland — Answer 6

Welcome to  
Quarantine Trivia  
IX!

## Question

In what year did the Irish win their independence from Great Britain?

## Answer

1921



Round 1

Round 2

Q1

Q2

Q3

Q4

Q5

Q6

Q7

Q8

Q9

Q10

Answers

Round 3

Round 4

Round 5

Round 6

Round 7

Round 8

Round 9

Round 10

Bonus Round

# Round 2 — Ireland — Answer 7

Welcome to  
Quarantine Trivia  
IX!

## Question

What is the name of the Yeats poem that includes the repeated line, “A terrible beauty is born”?

Round 1

Round 2

Q1

Q2

Q3

Q4

Q5

Q6

Q7

Q8

Q9

Q10

Answers

Round 3

Round 4

Round 5

Round 6

Round 7

Round 8

Round 9

Round 10

Bonus Round



## Round 2 — Ireland — Answer 7

Welcome to  
Quarantine Trivia  
IX!

### Question

What is the name of the Yeats poem that includes the repeated line, “A terrible beauty is born”?

### Answer

“Easter, 1916”



Round 1

Round 2

Q1

Q2

Q3

Q4

Q5

Q6

Q7

Q8

Q9

Q10

Answers

Round 3

Round 4

Round 5

Round 6

Round 7

Round 8

Round 9

Round 10

Bonus Round

# Round 2 — Ireland — Answer 8

Welcome to  
Quarantine Trivia  
IX!

## Question

What famous oratorio, performed annually around the world to this day, had its debut at The Great Music Hall in Dublin during lent in 1742?

Round 1

Round 2

Q1

Q2

Q3

Q4

Q5

Q6

Q7

Q8

Q9

Q10

Answers

Round 3

Round 4

Round 5

Round 6

Round 7

Round 8

Round 9

Round 10

Bonus Round

## Round 2 — Ireland — Answer 8

Welcome to  
Quarantine Trivia  
IX!

### Question

What famous oratorio, performed annually around the world to this day, had its debut at The Great Music Hall in Dublin during lent in 1742?

### Answer

Messiah /  
Handel's Messiah,  
by George Frideric  
Handel



Round 1

Round 2

Q1

Q2

Q3

Q4

Q5

Q6

Q7

Q8

Q9

Q10

Answers

Round 3

Round 4

Round 5

Round 6

Round 7

Round 8

Round 9

Round 10

Bonus Round

# Round 2 — Ireland — Answer 9

Welcome to  
Quarantine Trivia  
IX!

## Question

What was Yogi Berra's reported response to being told that Robert Briscoe, the Lord Mayor of Dublin, was Jewish?

Round 1

Round 2

Q1

Q2

Q3

Q4

Q5

Q6

Q7

Q8

Q9

Q10

Answers

Round 3

Round 4

Round 5

Round 6

Round 7

Round 8

Round 9

Round 10

Bonus Round

## Round 2 — Ireland — Answer 9

Welcome to  
Quarantine Trivia  
IX!

### Question

What was Yogi Berra's reported response to being told that Robert Briscoe, the Lord Mayor of Dublin, was Jewish?

### Answer

“Only in America!”



Round 1

Round 2

Q1

Q2

Q3

Q4

Q5

Q6

Q7

Q8

Q9

Q10

Answers

Round 3

Round 4

Round 5

Round 6

Round 7

Round 8

Round 9

Round 10

Bonus Round

# Round 2 — Ireland — Answer 10

Welcome to  
Quarantine Trivia  
IX!

## Question

According to legend, what animal did St. Patrick drive out of Ireland?

Round 1

Round 2

Q1

Q2

Q3

Q4

Q5

Q6

Q7

Q8

Q9

Q10

Answers

Round 3

Round 4

Round 5

Round 6

Round 7

Round 8

Round 9

Round 10

Bonus Round

# Round 2 — Ireland — Answer 10

Welcome to  
Quarantine Trivia  
IX!

## Question

According to legend, what animal did St. Patrick drive out of Ireland?

## Answer

Snakes



Round 1

Round 2

Q1

Q2

Q3

Q4

Q5

Q6

Q7

Q8

Q9

Q10

Answers

Round 3

Round 4

Round 5

Round 6

Round 7

Round 8

Round 9

Round 10

Bonus Round

Round 1

Round 2

**Round 3**

Q1

Q2

Q3

Q4

Q5

Q6

Q7

Q8

Q9

Q10

Answers

Round 4

Round 5

Round 6

Round 7

Round 8

Round 9

Round 10

Bonus Round

## Round 3

### Colonial America

Please mute yourselves!



# Round 3 — Colonial America — Question 1

Welcome to  
Quarantine Trivia  
IX!

## Question

The 16<sup>th</sup> century settlement known as the “Lost Colony”, whose population mysteriously disappeared, was situated on which island in North Carolina?

Round 1

Round 2

Round 3

Q1

Q2

Q3

Q4

Q5

Q6

Q7

Q8

Q9

Q10

Answers

Round 4

Round 5

Round 6

Round 7

Round 8

Round 9

Round 10

Bonus Round

# Round 3 — Colonial America — Question 2

Welcome to  
Quarantine Trivia  
IX!

## Question

What was the name of the first permanent English settlement in America?

Round 1

Round 2

Round 3

Q1

**Q2**

Q3

Q4

Q5

Q6

Q7

Q8

Q9

Q10

Answers

Round 4

Round 5

Round 6

Round 7

Round 8

Round 9

Round 10

Bonus Round

# Round 3 — Colonial America — Question 3

Welcome to  
Quarantine Trivia  
IX!

## Question

What was the name of Pocahontas' husband?

Round 1

Round 2

Round 3

Q1

Q2

**Q3**

Q4

Q5

Q6

Q7

Q8

Q9

Q10

Answers

Round 4

Round 5

Round 6

Round 7

Round 8

Round 9

Round 10

Bonus Round

# Round 3 — Colonial America — Question 4

Welcome to  
Quarantine Trivia  
IX!

## Question

In perhaps the first recorded instance of American exceptionalism, John Winthrop, one of the founders of the Massachusetts Bay Colony, used what Biblical phrase to describe the prominence their colony would have in the world?

Round 1

Round 2

Round 3

Q1

Q2

Q3

**Q4**

Q5

Q6

Q7

Q8

Q9

Q10

Answers

Round 4

Round 5

Round 6

Round 7

Round 8

Round 9

Round 10

Bonus Round

# Round 3 — Colonial America — Question 5

Welcome to  
Quarantine Trivia  
IX!

## Question

Which colony, founded in 1635 by a Puritan dissident, was the first to grant religious freedom to its inhabitants?

Round 1

Round 2

Round 3

Q1

Q2

Q3

Q4

**Q5**

Q6

Q7

Q8

Q9

Q10

Answers

Round 4

Round 5

Round 6

Round 7

Round 8

Round 9

Round 10

Bonus Round

# Round 3 — Colonial America — Question 6

Welcome to  
Quarantine Trivia  
IX!

## Question

Which Revolutionary War hero, who was executed by the British after being captured during a spy mission, said as his last words, “I only regret that I have but one life to lose for my country”?

Round 1

Round 2

Round 3

Q1

Q2

Q3

Q4

Q5

**Q6**

Q7

Q8

Q9

Q10

Answers

Round 4

Round 5

Round 6

Round 7

Round 8

Round 9

Round 10

Bonus Round

# Round 3 — Colonial America — Question 7

Welcome to  
Quarantine Trivia  
IX!

## Question

Which religious group in colonial America published the first argument in favor of the abolition of slavery?

Round 1

Round 2

Round 3

Q1

Q2

Q3

Q4

Q5

Q6

**Q7**

Q8

Q9

Q10

Answers

Round 4

Round 5

Round 6

Round 7

Round 8

Round 9

Round 10

Bonus Round

# Round 3 — Colonial America — Question 8

Welcome to  
Quarantine Trivia  
IX!

## Question

In what year did the Boston Tea Party occur?

Round 1

Round 2

Round 3

Q1

Q2

Q3

Q4

Q5

Q6

Q7

**Q8**

Q9

Q10

Answers

Round 4

Round 5

Round 6

Round 7

Round 8

Round 9

Round 10

Bonus Round



# Round 3 — Colonial America — Question 9

Welcome to  
Quarantine Trivia  
IX!

## Question

The leading judge in the Salem Witch Trials was an ancestor of a famous 19<sup>th</sup> century American writer. What was the writer's name?

Round 1

Round 2

Round 3

Q1

Q2

Q3

Q4

Q5

Q6

Q7

Q8

**Q9**

Q10

Answers

Round 4

Round 5

Round 6

Round 7

Round 8

Round 9

Round 10

Bonus Round

## Round 3 — Colonial America — Question 10

Welcome to  
Quarantine Trivia  
IX!

### Question

Which founding father published the political cartoon pictured here in the *Pennsylvania Gazette* in 1754?



Round 1

Round 2

Round 3

Q1

Q2

Q3

Q4

Q5

Q6

Q7

Q8

Q9

Q10

Answers

Round 4

Round 5

Round 6

Round 7

Round 8

Round 9

Round 10

Bonus Round

Round 1

Round 2

Round 3

Q1

Q2

Q3

Q4

Q5

Q6

Q7

Q8

Q9

Q10

Answers

Round 4

Round 5

Round 6

Round 7

Round 8

Round 9

Round 10

Bonus Round

## Round 3

### Answers

Unmute yourselves!

# Round 3 — Colonial America — Answer 1

Welcome to  
Quarantine Trivia  
IX!

## Question

The 16<sup>th</sup> century settlement known as the “Lost Colony”, whose population mysteriously disappeared, was situated on which island in North Carolina?

Round 1

Round 2

Round 3

Q1

Q2

Q3

Q4

Q5

Q6

Q7

Q8

Q9

Q10

Answers

Round 4

Round 5

Round 6

Round 7

Round 8

Round 9

Round 10

Bonus Round

# Round 3 — Colonial America — Answer 1

Welcome to  
Quarantine Trivia  
IX!

## Question

The 16<sup>th</sup> century settlement known as the “Lost Colony”, whose population mysteriously disappeared, was situated on which island in North Carolina?

## Answer

Roanoke



Round 1

Round 2

Round 3

Q1

Q2

Q3

Q4

Q5

Q6

Q7

Q8

Q9

Q10

Answers

Round 4

Round 5

Round 6

Round 7

Round 8

Round 9

Round 10

Bonus Round

# Round 3 — Colonial America — Answer 2

Welcome to  
Quarantine Trivia  
IX!

## Question

What was the name of the first permanent English settlement in America?

Round 1

Round 2

Round 3

Q1

Q2

Q3

Q4

Q5

Q6

Q7

Q8

Q9

Q10

Answers

Round 4

Round 5

Round 6

Round 7

Round 8

Round 9

Round 10

Bonus Round

## Round 3 — Colonial America — Answer 2

Welcome to  
Quarantine Trivia  
IX!

### Question

What was the name of the first permanent English settlement in America?

### Answer

Jamestown,  
Virginia



Round 1

Round 2

Round 3

Q1

Q2

Q3

Q4

Q5

Q6

Q7

Q8

Q9

Q10

Answers

Round 4

Round 5

Round 6

Round 7

Round 8

Round 9

Round 10

Bonus Round

# Round 3 — Colonial America — Answer 3

Welcome to  
Quarantine Trivia  
IX!

## Question

What was the name of Pocahontas' husband?

Round 1

Round 2

Round 3

Q1

Q2

Q3

Q4

Q5

Q6

Q7

Q8

Q9

Q10

Answers

Round 4

Round 5

Round 6

Round 7

Round 8

Round 9

Round 10

Bonus Round



# Round 3 — Colonial America — Answer 3

Welcome to  
Quarantine Trivia  
IX!

## Question

What was the name of Pocahontas' husband?

## Answer

John Rolfe



Round 1

Round 2

Round 3

Q1

Q2

Q3

Q4

Q5

Q6

Q7

Q8

Q9

Q10

Answers

Round 4

Round 5

Round 6

Round 7

Round 8

Round 9

Round 10

Bonus Round

# Round 3 — Colonial America — Answer 4

Welcome to  
Quarantine Trivia  
IX!

## Question

In perhaps the first recorded instance of American exceptionalism, John Winthrop, one of the founders of the Massachusetts Bay Colony, used what Biblical phrase to describe the prominence their colony would have in the world?

Round 1

Round 2

Round 3

Q1

Q2

Q3

Q4

Q5

Q6

Q7

Q8

Q9

Q10

Answers

Round 4

Round 5

Round 6

Round 7

Round 8

Round 9

Round 10

Bonus Round

# Round 3 — Colonial America — Answer 4

Welcome to  
Quarantine Trivia  
IX!

## Question

In perhaps the first recorded instance of American exceptionalism, John Winthrop, one of the founders of the Massachusetts Bay Colony, used what Biblical phrase to describe the prominence their colony would have in the world?

## Answer

As a “city upon a hill” (Matthew 5:14)

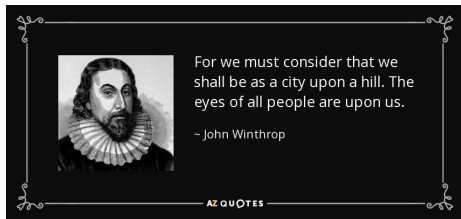

Round 1

Round 2

Round 3

Q1

Q2

Q3

Q4

Q5

Q6

Q7

Q8

Q9

Q10

Answers

Round 4

Round 5

Round 6

Round 7

Round 8

Round 9

Round 10

Bonus Round

# Round 3 — Colonial America — Answer 5

Welcome to  
Quarantine Trivia  
IX!

## Question

Which colony, founded in 1635 by a Puritan dissident, was the first to grant religious freedom to its inhabitants?

Round 1

Round 2

Round 3

Q1

Q2

Q3

Q4

Q5

Q6

Q7

Q8

Q9

Q10

Answers

Round 4

Round 5

Round 6

Round 7

Round 8

Round 9

Round 10

Bonus Round

# Round 3 — Colonial America — Answer 5

Welcome to  
Quarantine Trivia  
IX!

## Question

Which colony, founded in 1635 by a Puritan dissident, was the first to grant religious freedom to its inhabitants?

## Answer

Rhode Island



SETTLEMENT OF RHODE ISLAND

Round 1

Round 2

Round 3

Q1

Q2

Q3

Q4

Q5

Q6

Q7

Q8

Q9

Q10

Answers

Round 4

Round 5

Round 6

Round 7

Round 8

Round 9

Round 10

Bonus Round

# Round 3 — Colonial America — Answer 6

Welcome to  
Quarantine Trivia  
IX!

## Question

Which Revolutionary War hero, who was executed by the British after being captured during a spy mission, said as his last words, “I only regret that I have but one life to lose for my country”?

Round 1

Round 2

Round 3

Q1

Q2

Q3

Q4

Q5

Q6

Q7

Q8

Q9

Q10

Answers

Round 4

Round 5

Round 6

Round 7

Round 8

Round 9

Round 10

Bonus Round

# Round 3 — Colonial America — Answer 6

Welcome to  
Quarantine Trivia  
IX!

## Question

Which Revolutionary War hero, who was executed by the British after being captured during a spy mission, said as his last words, “I only regret that I have but one life to lose for my country”?

## Answer

Nathan Hale



Round 1

Round 2

Round 3

Q1

Q2

Q3

Q4

Q5

Q6

Q7

Q8

Q9

Q10

Answers

Round 4

Round 5

Round 6

Round 7

Round 8

Round 9

Round 10

Bonus Round

# Round 3 — Colonial America — Answer 7

Welcome to  
Quarantine Trivia  
IX!

## Question

Which religious group in colonial America published the first argument in favor of the abolition of slavery?

Round 1

Round 2

Round 3

Q1

Q2

Q3

Q4

Q5

Q6

Q7

Q8

Q9

Q10

Answers

Round 4

Round 5

Round 6

Round 7

Round 8

Round 9

Round 10

Bonus Round



# Round 3 — Colonial America — Answer 7

Welcome to  
Quarantine Trivia  
IX!

## Question

Which religious group in colonial America published the first argument in favor of the abolition of slavery?

## Answer

The Quakers (in  
1688)

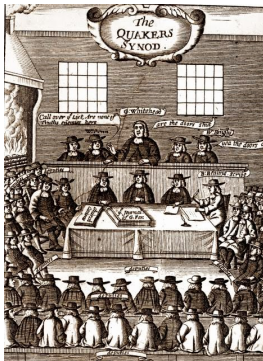

Round 1

Round 2

Round 3

Q1

Q2

Q3

Q4

Q5

Q6

Q7

Q8

Q9

Q10

Answers

Round 4

Round 5

Round 6

Round 7

Round 8

Round 9

Round 10

Bonus Round

# Round 3 — Colonial America — Answer 8

Welcome to  
Quarantine Trivia  
IX!

## Question

In what year did the Boston Tea Party occur?

Round 1

Round 2

Round 3

Q1

Q2

Q3

Q4

Q5

Q6

Q7

Q8

Q9

Q10

Answers

Round 4

Round 5

Round 6

Round 7

Round 8

Round 9

Round 10

Bonus Round

# Round 3 — Colonial America — Answer 8

Welcome to  
Quarantine Trivia  
IX!

## Question

In what year did the Boston Tea Party occur?

## Answer

1773

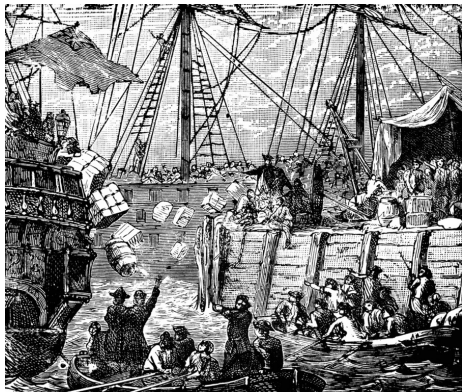

Round 1

Round 2

Round 3

Q1

Q2

Q3

Q4

Q5

Q6

Q7

Q8

Q9

Q10

Answers

Round 4

Round 5

Round 6

Round 7

Round 8

Round 9

Round 10

Bonus Round

# Round 3 — Colonial America — Answer 9

Welcome to  
Quarantine Trivia  
IX!

## Question

The leading judge in the Salem Witch Trials was an ancestor of a famous 19<sup>th</sup> century American writer. What was the writer's name?

Round 1

Round 2

Round 3

Q1

Q2

Q3

Q4

Q5

Q6

Q7

Q8

Q9

Q10

Answers

Round 4

Round 5

Round 6

Round 7

Round 8

Round 9

Round 10

Bonus Round

## Round 3 — Colonial America — Answer 9

Welcome to  
Quarantine Trivia  
IX!

### Question

The leading judge in the Salem Witch Trials was an ancestor of a famous 19<sup>th</sup> century American writer. What was the writer's name?

### Answer

Nathaniel Hawthorne. (His ancestor was John Hathorne. Hawthorne added the “w” to his last name to disassociate himself from his ancestor.)

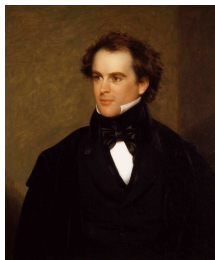

Round 1

Round 2

Round 3

Q1

Q2

Q3

Q4

Q5

Q6

Q7

Q8

Q9

Q10

Answers

Round 4

Round 5

Round 6

Round 7

Round 8

Round 9

Round 10

Bonus Round

## Round 3 — Colonial America — Answer 10

Welcome to  
Quarantine Trivia  
IX!

### Question

Which founding father published the political cartoon pictured here in the *Pennsylvania Gazette* in 1754?

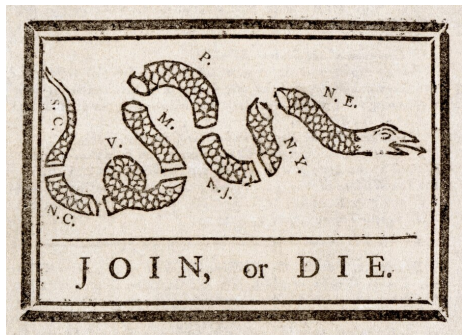

Round 1

Round 2

Round 3

Q1

Q2

Q3

Q4

Q5

Q6

Q7

Q8

Q9

Q10

Answers

Round 4

Round 5

Round 6

Round 7

Round 8

Round 9

Round 10

Bonus Round

## Round 3 — Colonial America — Answer 10

Welcome to  
Quarantine Trivia  
IX!

### Question

Which founding father published the political cartoon pictured here in the *Pennsylvania Gazette* in 1754?

### Answer

Benjamin Franklin

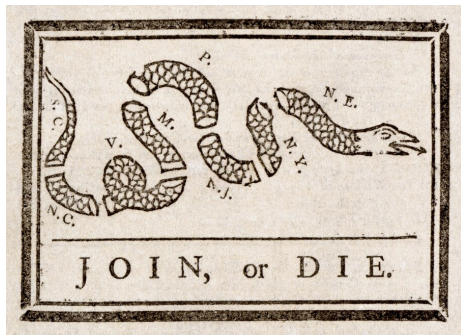

Round 1

Round 2

Round 3

Q1

Q2

Q3

Q4

Q5

Q6

Q7

Q8

Q9

Q10

Answers

Round 4

Round 5

Round 6

Round 7

Round 8

Round 9

Round 10

Bonus Round

Round 1

Round 2

Round 3

**Round 4**

Q1

Q2

Q3

Q4

Q5

Q6

Q7

Q8

Q9

Q10

Answers

Round 5

Round 6

Round 7

Round 8

Round 9

Round 10

Bonus Round

## Round 4

### Famous Ships and Boats

Please mute yourselves!



# Round 4 — Famous Ships and Boats — Question 1

Welcome to  
Quarantine Trivia  
IX!

## Question

What was the alpha-numeric designation of the boat that was under the command of Navy Lt. JG John F. Kennedy when it was rammed by a Japanese destroyer during WWII?

Round 1

Round 2

Round 3

Round 4

Q1

Q2

Q3

Q4

Q5

Q6

Q7

Q8

Q9

Q10

Answers

Round 5

Round 6

Round 7

Round 8

Round 9

Round 10

Bonus Round

# Round 4 — Famous Ships and Boats — Question 2

Welcome to  
Quarantine Trivia  
IX!

## Question

Name either of the Titanic's sister ships.

Round 1

Round 2

Round 3

Round 4

Q1

**Q2**

Q3

Q4

Q5

Q6

Q7

Q8

Q9

Q10

Answers

Round 5

Round 6

Round 7

Round 8

Round 9

Round 10

Bonus Round

# Round 4 — Famous Ships and Boats — Question 3

Welcome to  
Quarantine Trivia  
IX!

## Question

What were the names of Columbus' ships? (We need them all.)

Round 1

Round 2

Round 3

Round 4

Q1

Q2

**Q3**

Q4

Q5

Q6

Q7

Q8

Q9

Q10

Answers

Round 5

Round 6

Round 7

Round 8

Round 9

Round 10

Bonus Round

# Round 4 — Famous Ships and Boats — Question 4

Welcome to  
Quarantine Trivia  
IX!

## Question

What ship is known by the name “Old Ironsides”?

Round 1

Round 2

Round 3

Round 4

Q1

Q2

Q3

**Q4**

Q5

Q6

Q7

Q8

Q9

Q10

Answers

Round 5

Round 6

Round 7

Round 8

Round 9

Round 10

Bonus Round

# Round 4 — Famous Ships and Boats — Question 5

Welcome to  
Quarantine Trivia  
IX!

## Question

What is the name of the Italian liner that sank in 1956 with the loss of 46 lives?

Round 1

Round 2

Round 3

Round 4

Q1

Q2

Q3

Q4

**Q5**

Q6

Q7

Q8

Q9

Q10

Answers

Round 5

Round 6

Round 7

Round 8

Round 9

Round 10

Bonus Round

# Round 4 — Famous Ships and Boats — Question 6

Welcome to  
Quarantine Trivia  
IX!

## Question

What is the name of ship the capsizing of which in 2012 resulted in worldwide condemnation of its captain when he abandoned the ship while passengers and crew were still on board?

Round 1

Round 2

Round 3

Round 4

Q1

Q2

Q3

Q4

Q5

**Q6**

Q7

Q8

Q9

Q10

Answers

Round 5

Round 6

Round 7

Round 8

Round 9

Round 10

Bonus Round

# Round 4 — Famous Ships and Boats — Question 7

Welcome to  
Quarantine Trivia  
IX!

## Question

What is the name of the ship on which Japan formally surrendered to the U.S. at the end of WWII?

Round 1

Round 2

Round 3

Round 4

Q1

Q2

Q3

Q4

Q5

Q6

**Q7**

Q8

Q9

Q10

Answers

Round 5

Round 6

Round 7

Round 8

Round 9

Round 10

Bonus Round

# Round 4 — Famous Ships and Boats — Question 8

Welcome to  
Quarantine Trivia  
IX!

## Question

What is the name of the American ship that exploded under mysterious circumstances in Havana harbor in February 1898?

Round 1

Round 2

Round 3

Round 4

Q1

Q2

Q3

Q4

Q5

Q6

Q7

**Q8**

Q9

Q10

Answers

Round 5

Round 6

Round 7

Round 8

Round 9

Round 10

Bonus Round



# Round 4 — Famous Ships and Boats — Question 9

Welcome to  
Quarantine Trivia  
IX!

## Question

This ship, one of only three American aircraft carriers commissioned before World War II to survive the war, participated in the course of the war in more major actions against Japan than any other United States ship.

Round 1

Round 2

Round 3

Round 4

Q1

Q2

Q3

Q4

Q5

Q6

Q7

Q8

**Q9**

Q10

Answers

Round 5

Round 6

Round 7

Round 8

Round 9

Round 10

Bonus Round

# Round 4 — Famous Ships and Boats — Question 10

Welcome to  
Quarantine Trivia  
IX!

## Question

What was the name of the ship on which Henry Hudson sailed when he explored the river that would someday bear his name?

Round 1

Round 2

Round 3

Round 4

Q1

Q2

Q3

Q4

Q5

Q6

Q7

Q8

Q9

**Q10**

Answers

Round 5

Round 6

Round 7

Round 8

Round 9

Round 10

Bonus Round

Round 1

Round 2

Round 3

Round 4

Q1

Q2

Q3

Q4

Q5

Q6

Q7

Q8

Q9

Q10

Answers

Round 5

Round 6

Round 7

Round 8

Round 9

Round 10

Bonus Round

## Round 4 Answers

Unmute yourselves!

# Round 4 — Famous Ships and Boats — Answer 1

Welcome to  
Quarantine Trivia  
IX!

## Question

What was the alpha-numeric designation of the boat that was under the command of Navy Lt. JG John F. Kennedy when it was rammed by a Japanese destroyer during WWII?

Round 1

Round 2

Round 3

Round 4

Q1

Q2

Q3

Q4

Q5

Q6

Q7

Q8

Q9

Q10

Answers

Round 5

Round 6

Round 7

Round 8

Round 9

Round 10

Bonus Round

# Round 4 — Famous Ships and Boats — Answer 1

Welcome to  
Quarantine Trivia  
IX!

## Question

What was the alpha-numeric designation of the boat that was under the command of Navy Lt. JG John F. Kennedy when it was rammed by a Japanese destroyer during WWII?

## Answer

PT-109



Round 1

Round 2

Round 3

Round 4

Q1

Q2

Q3

Q4

Q5

Q6

Q7

Q8

Q9

Q10

Answers

Round 5

Round 6

Round 7

Round 8

Round 9

Round 10

Bonus Round

# Round 4 — Famous Ships and Boats — Answer 2

Welcome to  
Quarantine Trivia  
IX!

## Question

Name either of the Titanic's sister ships.

Round 1

Round 2

Round 3

Round 4

Q1

Q2

Q3

Q4

Q5

Q6

Q7

Q8

Q9

Q10

Answers

Round 5

Round 6

Round 7

Round 8

Round 9

Round 10

Bonus Round

# Round 4 — Famous Ships and Boats — Answer 2

Welcome to  
Quarantine Trivia  
IX!

## Question

Name either of the Titanic's sister ships.

## Answer

*Britannic* and  
*Olympic* (you only  
need one of them)



Round 1

Round 2

Round 3

Round 4

Q1

Q2

Q3

Q4

Q5

Q6

Q7

Q8

Q9

Q10

Answers

Round 5

Round 6

Round 7

Round 8

Round 9

Round 10

Bonus Round

# Round 4 — Famous Ships and Boats — Answer 3

Welcome to  
Quarantine Trivia  
IX!

## Question

What were the names of Columbus' ships? (We need them all.)

Round 1

Round 2

Round 3

Round 4

Q1

Q2

Q3

Q4

Q5

Q6

Q7

Q8

Q9

Q10

Answers

Round 5

Round 6

Round 7

Round 8

Round 9

Round 10

Bonus Round



# Round 4 — Famous Ships and Boats — Answer 3

Welcome to  
Quarantine Trivia  
IX!

## Question

What were the names of Columbus' ships? (We need them all.)

## Answer

The Niña, the  
Pinta and the  
Santa Maria



Round 1

Round 2

Round 3

Round 4

Q1

Q2

Q3

Q4

Q5

Q6

Q7

Q8

Q9

Q10

Answers

Round 5

Round 6

Round 7

Round 8

Round 9

Round 10

Bonus Round

# Round 4 — Famous Ships and Boats — Answer 4

Welcome to  
Quarantine Trivia  
IX!

## Question

What ship is known by the name “Old Ironsides”?

Round 1

Round 2

Round 3

Round 4

Q1

Q2

Q3

Q4

Q5

Q6

Q7

Q8

Q9

Q10

Answers

Round 5

Round 6

Round 7

Round 8

Round 9

Round 10

Bonus Round

# Round 4 — Famous Ships and Boats — Answer 4

Welcome to  
Quarantine Trivia  
IX!

## Question

What ship is known by the name “Old Ironsides”?

## Answer

The U.S.S.  
Constitution



Round 1

Round 2

Round 3

Round 4

Q1

Q2

Q3

Q4

Q5

Q6

Q7

Q8

Q9

Q10

Answers

Round 5

Round 6

Round 7

Round 8

Round 9

Round 10

Bonus Round

# Round 4 — Famous Ships and Boats — Answer 5

Welcome to  
Quarantine Trivia  
IX!

## Question

What is the name of the Italian liner that sank in 1956 with the loss of 46 lives?

Round 1

Round 2

Round 3

Round 4

Q1

Q2

Q3

Q4

Q5

Q6

Q7

Q8

Q9

Q10

Answers

Round 5

Round 6

Round 7

Round 8

Round 9

Round 10

Bonus Round

# Round 4 — Famous Ships and Boats — Answer 5

Welcome to  
Quarantine Trivia  
IX!

## Question

What is the name of the Italian liner that sank in 1956 with the loss of 46 lives?

## Answer

The Andrea Doria  
(and George did  
not get the  
apartment)



Round 1

Round 2

Round 3

Round 4

Q1

Q2

Q3

Q4

Q5

Q6

Q7

Q8

Q9

Q10

Answers

Round 5

Round 6

Round 7

Round 8

Round 9

Round 10

Bonus Round

# Round 4 — Famous Ships and Boats — Answer 6

Welcome to  
Quarantine Trivia  
IX!

## Question

What is the name of ship the capsizing of which in 2012 resulted in worldwide condemnation of its captain when he abandoned the ship while passengers and crew were still on board?

Round 1

Round 2

Round 3

Round 4

Q1

Q2

Q3

Q4

Q5

Q6

Q7

Q8

Q9

Q10

Answers

Round 5

Round 6

Round 7

Round 8

Round 9

Round 10

Bonus Round

# Round 4 — Famous Ships and Boats — Answer 6

Welcome to  
Quarantine Trivia  
IX!

## Question

What is the name of ship the capsizing of which in 2012 resulted in worldwide condemnation of its captain when he abandoned the ship while passengers and crew were still on board?

## Answer

The Costa Concordia. (The Italian Coast Guard famously radioed the captain, Francesco Schettino, to “Get the f\*\*k on board” (“Vada a bordo, cazzo!”))



Round 1

Round 2

Round 3

Round 4

Q1

Q2

Q3

Q4

Q5

Q6

Q7

Q8

Q9

Q10

Answers

Round 5

Round 6

Round 7

Round 8

Round 9

Round 10

Bonus Round

# Round 4 — Famous Ships and Boats — Answer 7

Welcome to  
Quarantine Trivia  
IX!

## Question

What is the name of the ship on which Japan formally surrendered to the U.S. at the end of WWII?

Round 1

Round 2

Round 3

Round 4

Q1

Q2

Q3

Q4

Q5

Q6

Q7

Q8

Q9

Q10

Answers

Round 5

Round 6

Round 7

Round 8

Round 9

Round 10

Bonus Round



# Round 4 — Famous Ships and Boats — Answer 7

Welcome to  
Quarantine Trivia  
IX!

## Question

What is the name of the ship on which Japan formally surrendered to the U.S. at the end of WWII?

## Answer

The U.S.S.  
Missouri



Round 1

Round 2

Round 3

Round 4

Q1

Q2

Q3

Q4

Q5

Q6

Q7

Q8

Q9

Q10

Answers

Round 5

Round 6

Round 7

Round 8

Round 9

Round 10

Bonus Round

# Round 4 — Famous Ships and Boats — Answer 8

Welcome to  
Quarantine Trivia  
IX!

## Question

What is the name of the American ship that exploded under mysterious circumstances in Havana harbor in February 1898?

Round 1

Round 2

Round 3

Round 4

Q1

Q2

Q3

Q4

Q5

Q6

Q7

Q8

Q9

Q10

Answers

Round 5

Round 6

Round 7

Round 8

Round 9

Round 10

Bonus Round

# Round 4 — Famous Ships and Boats — Answer 8

Welcome to  
Quarantine Trivia  
IX!

## Question

What is the name of the American ship that exploded under mysterious circumstances in Havana harbor in February 1898?

## Answer

The U.S.S. Maine



Round 1

Round 2

Round 3

Round 4

Q1

Q2

Q3

Q4

Q5

Q6

Q7

Q8

Q9

Q10

Answers

Round 5

Round 6

Round 7

Round 8

Round 9

Round 10

Bonus Round

# Round 4 — Famous Ships and Boats — Answer 9

Welcome to  
Quarantine Trivia  
IX!

## Question

This ship, one of only three American aircraft carriers commissioned before World War II to survive the war, participated in the course of the war in more major actions against Japan than any other United States ship.

Round 1

Round 2

Round 3

Round 4

Q1

Q2

Q3

Q4

Q5

Q6

Q7

Q8

Q9

Q10

Answers

Round 5

Round 6

Round 7

Round 8

Round 9

Round 10

Bonus Round

# Round 4 — Famous Ships and Boats — Answer 9

Welcome to  
Quarantine Trivia  
IX!

## Question

This ship, one of only three American aircraft carriers commissioned before World War II to survive the war, participated in the course of the war in more major actions against Japan than any other United States ship.

## Answer

The U.S.S.  
Enterprise

Photo # 80-G-701166 USS Enterprise underway, October 1945



Round 1

Round 2

Round 3

Round 4

Q1

Q2

Q3

Q4

Q5

Q6

Q7

Q8

Q9

Q10

Answers

Round 5

Round 6

Round 7

Round 8

Round 9

Round 10

Bonus Round

# Round 4 — Famous Ships and Boats — Answer 10

Welcome to  
Quarantine Trivia  
IX!

## Question

What was the name of the ship on which Henry Hudson sailed when he explored the river that would someday bear his name?

Round 1

Round 2

Round 3

Round 4

Q1

Q2

Q3

Q4

Q5

Q6

Q7

Q8

Q9

Q10

Answers

Round 5

Round 6

Round 7

Round 8

Round 9

Round 10

Bonus Round

# Round 4 — Famous Ships and Boats — Answer 10

Welcome to  
Quarantine Trivia  
IX!

## Question

What was the name of the ship on which Henry Hudson sailed when he explored the river that would someday bear his name?

## Answer

The Half Moon



Round 1

Round 2

Round 3

Round 4

Q1

Q2

Q3

Q4

Q5

Q6

Q7

Q8

Q9

Q10

Answers

Round 5

Round 6

Round 7

Round 8

Round 9

Round 10

Bonus Round

Round 1

Round 2

Round 3

Round 4

**Round 5**

Q1

Q2

Q3

Q4

Q5

Q6

Q7

Q8

Q9

Q10

Answers

Round 6

Round 7

Round 8

Round 9

Round 10

Bonus Round

## Round 5

### Foreign Words and Phrases

Please mute yourselves!



# Round 5 — Foreign Words and Phrases — Question 1

Welcome to  
Quarantine Trivia  
IX!

## Question

Proxime accessit

Round 1

Round 2

Round 3

Round 4

Round 5

Q1

Q2

Q3

Q4

Q5

Q6

Q7

Q8

Q9

Q10

Answers

Round 6

Round 7

Round 8

Round 9

Round 10

Bonus Round

# Round 5 — Foreign Words and Phrases — Question 2

Welcome to  
Quarantine Trivia  
IX!

## Question

Persona non grata

Round 1

Round 2

Round 3

Round 4

Round 5

Q1

**Q2**

Q3

Q4

Q5

Q6

Q7

Q8

Q9

Q10

Answers

Round 6

Round 7

Round 8

Round 9

Round 10

Bonus Round

# Round 5 — Foreign Words and Phrases — Question 3

Welcome to  
Quarantine Trivia  
IX!

## Question

Au courant

Round 1

Round 2

Round 3

Round 4

Round 5

Q1

Q2

**Q3**

Q4

Q5

Q6

Q7

Q8

Q9

Q10

Answers

Round 6

Round 7

Round 8

Round 9

Round 10

Bonus Round

# Round 5 — Foreign Words and Phrases — Question 4

Welcome to  
Quarantine Trivia  
IX!

## Question

Beaux arts

Round 1

Round 2

Round 3

Round 4

Round 5

Q1

Q2

Q3

**Q4**

Q5

Q6

Q7

Q8

Q9

Q10

Answers

Round 6

Round 7

Round 8

Round 9

Round 10

Bonus Round

# Round 5 — Foreign Words and Phrases — Question 5

Welcome to  
Quarantine Trivia  
IX!

## Question

Caveat emptor

Round 1

Round 2

Round 3

Round 4

Round 5

Q1

Q2

Q3

Q4

**Q5**

Q6

Q7

Q8

Q9

Q10

Answers

Round 6

Round 7

Round 8

Round 9

Round 10

Bonus Round

# Round 5 — Foreign Words and Phrases — Question 6

Welcome to  
Quarantine Trivia  
IX!

## Question

In medias res

Round 1

Round 2

Round 3

Round 4

Round 5

Q1

Q2

Q3

Q4

Q5

**Q6**

Q7

Q8

Q9

Q10

Answers

Round 6

Round 7

Round 8

Round 9

Round 10

Bonus Round

# Round 5 — Foreign Words and Phrases — Question 7

Welcome to  
Quarantine Trivia  
IX!

## Question

Unheimlich

Round 1

Round 2

Round 3

Round 4

Round 5

Q1

Q2

Q3

Q4

Q5

Q6

**Q7**

Q8

Q9

Q10

Answers

Round 6

Round 7

Round 8

Round 9

Round 10

Bonus Round

# Round 5 — Foreign Words and Phrases — Question 8

Welcome to  
Quarantine Trivia  
IX!

## Question

Katzenjammer

Round 1

Round 2

Round 3

Round 4

Round 5

Q1

Q2

Q3

Q4

Q5

Q6

Q7

**Q8**

Q9

Q10

Answers

Round 6

Round 7

Round 8

Round 9

Round 10

Bonus Round



# Round 5 — Foreign Words and Phrases — Question 9

Welcome to  
Quarantine Trivia  
IX!

## Question

Plus ça change, plus c'est la même chose.

Round 1

Round 2

Round 3

Round 4

Round 5

Q1

Q2

Q3

Q4

Q5

Q6

Q7

Q8

**Q9**

Q10

Answers

Round 6

Round 7

Round 8

Round 9

Round 10

Bonus Round

# Round 5 — Foreign Words and Phrases — Question 10

Welcome to  
Quarantine Trivia  
IX!

## Question

Sui generis

Round 1

Round 2

Round 3

Round 4

Round 5

Q1

Q2

Q3

Q4

Q5

Q6

Q7

Q8

Q9

**Q10**

Answers

Round 6

Round 7

Round 8

Round 9

Round 10

Bonus Round

Round 1

Round 2

Round 3

Round 4

Round 5

Q1

Q2

Q3

Q4

Q5

Q6

Q7

Q8

Q9

Q10

Answers

Round 6

Round 7

Round 8

Round 9

Round 10

Bonus Round

## Round 5

### Answers

Unmute yourselves!

# Round 5 — Foreign Words and Phrases — Answer 1

Welcome to  
Quarantine Trivia  
IX!

## Question

Proxime accessit

Round 1

Round 2

Round 3

Round 4

Round 5

Q1

Q2

Q3

Q4

Q5

Q6

Q7

Q8

Q9

Q10

Answers

Round 6

Round 7

Round 8

Round 9

Round 10

Bonus Round

# Round 5 — Foreign Words and Phrases — Answer 1

Welcome to  
Quarantine Trivia  
IX!

## Question

Proxime accessit

## Answer

Person who comes  
in second / runner  
up



Round 1

Round 2

Round 3

Round 4

Round 5

Q1

Q2

Q3

Q4

Q5

Q6

Q7

Q8

Q9

Q10

Answers

Round 6

Round 7

Round 8

Round 9

Round 10

Bonus Round

# Round 5 — Foreign Words and Phrases — Answer 2

Welcome to  
Quarantine Trivia  
IX!

## Question

Persona non grata

Round 1

Round 2

Round 3

Round 4

Round 5

Q1

Q2

Q3

Q4

Q5

Q6

Q7

Q8

Q9

Q10

Answers

Round 6

Round 7

Round 8

Round 9

Round 10

Bonus Round

# Round 5 — Foreign Words and Phrases — Answer 2

Welcome to  
Quarantine Trivia  
IX!

## Question

Persona non grata

## Answer

An unwelcome or  
unacceptable  
person



Round 1

Round 2

Round 3

Round 4

Round 5

Q1

Q2

Q3

Q4

Q5

Q6

Q7

Q8

Q9

Q10

Answers

Round 6

Round 7

Round 8

Round 9

Round 10

Bonus Round

# Round 5 — Foreign Words and Phrases — Answer 3

## Question

Au courant

Welcome to  
Quarantine Trivia  
IX!

Round 1

Round 2

Round 3

Round 4

Round 5

Q1

Q2

Q3

Q4

Q5

Q6

Q7

Q8

Q9

Q10

**Answers**

Round 6

Round 7

Round 8

Round 9

Round 10

Bonus Round



# Round 5 — Foreign Words and Phrases — Answer 3

Welcome to  
Quarantine Trivia  
IX!

## Question

Au courant

## Answer

Up to date / well  
informed



Round 1

Round 2

Round 3

Round 4

Round 5

Q1

Q2

Q3

Q4

Q5

Q6

Q7

Q8

Q9

Q10

Answers

Round 6

Round 7

Round 8

Round 9

Round 10

Bonus Round

# Round 5 — Foreign Words and Phrases — Answer 4

## Question

Beaux arts

Welcome to  
Quarantine Trivia  
IX!

Round 1

Round 2

Round 3

Round 4

Round 5

Q1

Q2

Q3

Q4

Q5

Q6

Q7

Q8

Q9

Q10

Answers

Round 6

Round 7

Round 8

Round 9

Round 10

Bonus Round

# Round 5 — Foreign Words and Phrases — Answer 4

Question

Beaux arts

Answer

Fine arts



Welcome to  
Quarantine Trivia  
IX!

Round 1

Round 2

Round 3

Round 4

Round 5

Q1

Q2

Q3

Q4

Q5

Q6

Q7

Q8

Q9

Q10

Answers

Round 6

Round 7

Round 8

Round 9

Round 10

Bonus Round

# Round 5 — Foreign Words and Phrases — Answer 5

## Question

Caveat emptor

Welcome to  
Quarantine Trivia  
IX!

Round 1

Round 2

Round 3

Round 4

Round 5

Q1

Q2

Q3

Q4

Q5

Q6

Q7

Q8

Q9

Q10

Answers

Round 6

Round 7

Round 8

Round 9

Round 10

Bonus Round

# Round 5 — Foreign Words and Phrases — Answer 5

## Question

Caveat emptor

## Answer

Buyer beware



Welcome to  
Quarantine Trivia  
IX!

Round 1

Round 2

Round 3

Round 4

Round 5

Q1

Q2

Q3

Q4

Q5

Q6

Q7

Q8

Q9

Q10

Answers

Round 6

Round 7

Round 8

Round 9

Round 10

Bonus Round

# Round 5 — Foreign Words and Phrases — Answer 6

## Question

In medias res

Welcome to  
Quarantine Trivia  
IX!

Round 1

Round 2

Round 3

Round 4

Round 5

Q1

Q2

Q3

Q4

Q5

Q6

Q7

Q8

Q9

Q10

**Answers**

Round 6

Round 7

Round 8

Round 9

Round 10

Bonus Round

# Round 5 — Foreign Words and Phrases — Answer 6

Welcome to  
Quarantine Trivia  
IX!

## Question

In medias res

## Answer

In the middle of  
things

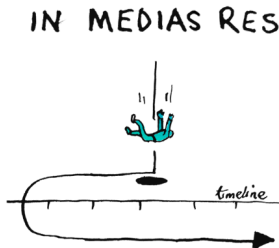

Round 1

Round 2

Round 3

Round 4

Round 5

Q1

Q2

Q3

Q4

Q5

Q6

Q7

Q8

Q9

Q10

Answers

Round 6

Round 7

Round 8

Round 9

Round 10

Bonus Round

# Round 5 — Foreign Words and Phrases — Answer 7

## Question

Unheimlich

Welcome to  
Quarantine Trivia  
IX!

Round 1

Round 2

Round 3

Round 4

Round 5

Q1

Q2

Q3

Q4

Q5

Q6

Q7

Q8

Q9

Q10

Answers

Round 6

Round 7

Round 8

Round 9

Round 10

Bonus Round



# Round 5 — Foreign Words and Phrases — Answer 7

Welcome to  
Quarantine Trivia  
IX!

## Question

Unheimlich

## Answer

Weird or uncanny



Round 1

Round 2

Round 3

Round 4

Round 5

Q1

Q2

Q3

Q4

Q5

Q6

Q7

Q8

Q9

Q10

Answers

Round 6

Round 7

Round 8

Round 9

Round 10

Bonus Round

# Round 5 — Foreign Words and Phrases — Answer 8

Welcome to  
Quarantine Trivia  
IX!

## Question

Katzenjammer

Round 1

Round 2

Round 3

Round 4

Round 5

Q1

Q2

Q3

Q4

Q5

Q6

Q7

Q8

Q9

Q10

Answers

Round 6

Round 7

Round 8

Round 9

Round 10

Bonus Round

# Round 5 — Foreign Words and Phrases — Answer 8

Welcome to  
Quarantine Trivia  
IX!

## Question

Katzenjammer

## Answer

A hangover / a  
severe headache  
accompanying a  
hangover /  
confusion and  
chaos



Round 1

Round 2

Round 3

Round 4

Round 5

Q1

Q2

Q3

Q4

Q5

Q6

Q7

Q8

Q9

Q10

Answers

Round 6

Round 7

Round 8

Round 9

Round 10

Bonus Round

# Round 5 — Foreign Words and Phrases — Answer 9

Welcome to  
Quarantine Trivia  
IX!

## Question

Plus ça change, plus c'est la même chose.

Round 1

Round 2

Round 3

Round 4

Round 5

Q1

Q2

Q3

Q4

Q5

Q6

Q7

Q8

Q9

Q10

Answers

Round 6

Round 7

Round 8

Round 9

Round 10

Bonus Round

# Round 5 — Foreign Words and Phrases — Answer 9

Welcome to  
Quarantine Trivia  
IX!

## Question

Plus ça change, plus c'est la même chose.

## Answer

The more things  
change, the more  
they stay the same



Round 1

Round 2

Round 3

Round 4

Round 5

Q1

Q2

Q3

Q4

Q5

Q6

Q7

Q8

Q9

Q10

Answers

Round 6

Round 7

Round 8

Round 9

Round 10

Bonus Round

# Round 5 — Foreign Words and Phrases — Answer 10

## Question

Sui generis

Welcome to  
Quarantine Trivia  
IX!

Round 1

Round 2

Round 3

Round 4

Round 5

Q1

Q2

Q3

Q4

Q5

Q6

Q7

Q8

Q9

Q10

Answers

Round 6

Round 7

Round 8

Round 9

Round 10

Bonus Round

# Round 5 — Foreign Words and Phrases — Answer 10

Welcome to  
Quarantine Trivia  
IX!

## Question

Sui generis

## Answer

Unique



Round 1

Round 2

Round 3

Round 4

Round 5

Q1

Q2

Q3

Q4

Q5

Q6

Q7

Q8

Q9

Q10

Answers

Round 6

Round 7

Round 8

Round 9

Round 10

Bonus Round

Round 1

Round 2

Round 3

Round 4

Round 5

**Round 6**

Q1

Q2

Q3

Q4

Q5

Q6

Q7

Q8

Q9

Q10

Answers

Round 7

Round 8

Round 9

Round 10

Bonus Round

## Round 6

### Birds

Please mute yourselves!



# Round 6 — Birds — Question 1

Welcome to  
Quarantine Trivia  
IX!

## Question

What kind of bird  
is pictured here?



Round 1

Round 2

Round 3

Round 4

Round 5

Round 6

Q1

Q2

Q3

Q4

Q5

Q6

Q7

Q8

Q9

Q10

Answers

Round 7

Round 8

Round 9

Round 10

Bonus Round

# Round 6 — Birds — Question 2

Welcome to  
Quarantine Trivia  
IX!

## Question

Charles Darwin first noticed the adaptation of animals to different biological niches after observing the different beak shapes of what kind of birds?

Round 1

Round 2

Round 3

Round 4

Round 5

Round 6

Q1

**Q2**

Q3

Q4

Q5

Q6

Q7

Q8

Q9

Q10

Answers

Round 7

Round 8

Round 9

Round 10

Bonus Round

# Round 6 — Birds — Question 3

Welcome to  
Quarantine Trivia  
IX!

## Question

Which extant species of bird has the longest wingspan?

Round 1

Round 2

Round 3

Round 4

Round 5

Round 6

Q1

Q2

**Q3**

Q4

Q5

Q6

Q7

Q8

Q9

Q10

Answers

Round 7

Round 8

Round 9

Round 10

Bonus Round

# Round 6 — Birds — Question 4

Welcome to  
Quarantine Trivia  
IX!

## Question

What is New Zealand's national bird?

Round 1

Round 2

Round 3

Round 4

Round 5

Round 6

Q1

Q2

Q3

**Q4**

Q5

Q6

Q7

Q8

Q9

Q10

Answers

Round 7

Round 8

Round 9

Round 10

Bonus Round

# Round 6 — Birds — Question 5

Welcome to  
Quarantine Trivia  
IX!

## Question

Which species of American bird went extinct in the wild in 1987 but, in a remarkable conservation success story, was bred in captivity and eventually released back into the wild?

Round 1

Round 2

Round 3

Round 4

Round 5

Round 6

Q1

Q2

Q3

Q4

**Q5**

Q6

Q7

Q8

Q9

Q10

Answers

Round 7

Round 8

Round 9

Round 10

Bonus Round

# Round 6 — Birds — Question 6

Welcome to  
Quarantine Trivia  
IX!

## Question

What is the word for a baby swan?

Round 1

Round 2

Round 3

Round 4

Round 5

Round 6

Q1

Q2

Q3

Q4

Q5

**Q6**

Q7

Q8

Q9

Q10

Answers

Round 7

Round 8

Round 9

Round 10

Bonus Round

# Round 6 — Birds — Question 7

Welcome to  
Quarantine Trivia  
IX!

## Question

What was the name of the gray parrot that could count up to six, identify shapes and colors by name, say over 100 English words, and is the only non-human to have ever asked a question?

Round 1

Round 2

Round 3

Round 4

Round 5

Round 6

Q1

Q2

Q3

Q4

Q5

Q6

**Q7**

Q8

Q9

Q10

Answers

Round 7

Round 8

Round 9

Round 10

Bonus Round

# Round 6 — Birds — Question 8

Welcome to  
Quarantine Trivia  
IX!

## Question

A murder is a group of crows and a parliament is a group of owls. A “flamboyance” is a group of what kind of birds?

Round 1

Round 2

Round 3

Round 4

Round 5

Round 6

Q1

Q2

Q3

Q4

Q5

Q6

Q7

**Q8**

Q9

Q10

Answers

Round 7

Round 8

Round 9

Round 10

Bonus Round



# Round 6 — Birds — Question 9

Welcome to  
Quarantine Trivia  
IX!

## Question

What kind of birds, known for being difficult to hunt due to their camouflage and erratic flight, lent their name to a word synonymous with “marksman”?

Round 1

Round 2

Round 3

Round 4

Round 5

Round 6

Q1

Q2

Q3

Q4

Q5

Q6

Q7

Q8

**Q9**

Q10

Answers

Round 7

Round 8

Round 9

Round 10

Bonus Round

# Round 6 — Birds — Question 10

Welcome to  
Quarantine Trivia  
IX!

## Question

Where in a bird's body is/are its wishbone(s) located?

Round 1

Round 2

Round 3

Round 4

Round 5

Round 6

Q1

Q2

Q3

Q4

Q5

Q6

Q7

Q8

Q9

**Q10**

Answers

Round 7

Round 8

Round 9

Round 10

Bonus Round

Round 1

Round 2

Round 3

Round 4

Round 5

Round 6

Q1

Q2

Q3

Q4

Q5

Q6

Q7

Q8

Q9

Q10

**Answers**

Round 7

Round 8

Round 9

Round 10

Bonus Round

## Round 6

### Answers

Unmute yourselves!

# Round 6 — Birds — Answer 1

Welcome to  
Quarantine Trivia  
IX!

## Question

What kind of bird  
is pictured here?



Round 1

Round 2

Round 3

Round 4

Round 5

Round 6

Q1

Q2

Q3

Q4

Q5

Q6

Q7

Q8

Q9

Q10

Answers

Round 7

Round 8

Round 9

Round 10

Bonus Round

# Round 6 — Birds — Answer 1

Welcome to  
Quarantine Trivia  
IX!

## Question

What kind of bird  
is pictured here?

## Answer

Starling /  
common starling /  
European starling



Round 1

Round 2

Round 3

Round 4

Round 5

Round 6

Q1

Q2

Q3

Q4

Q5

Q6

Q7

Q8

Q9

Q10

Answers

Round 7

Round 8

Round 9

Round 10

Bonus Round

# Round 6 — Birds — Answer 2

Welcome to  
Quarantine Trivia  
IX!

## Question

Charles Darwin first noticed the adaptation of animals to different biological niches after observing the different beak shapes of what kind of birds?

Round 1

Round 2

Round 3

Round 4

Round 5

Round 6

Q1

Q2

Q3

Q4

Q5

Q6

Q7

Q8

Q9

Q10

Answers

Round 7

Round 8

Round 9

Round 10

Bonus Round

# Round 6 — Birds — Answer 2

Welcome to  
Quarantine Trivia  
IX!

## Question

Charles Darwin first noticed the adaptation of animals to different biological niches after observing the different beak shapes of what kind of birds?

## Answer

Finches

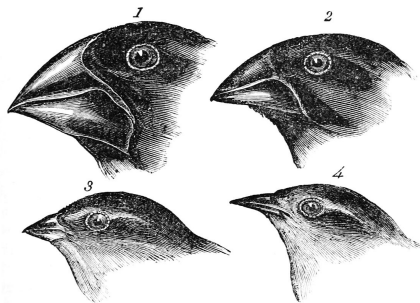

1. *Geospiza magnirostris*.  
3. *Geospiza parvula*.

2. *Geospiza fortis*.  
4. *Certhidea olivacea*.

Round 1

Round 2

Round 3

Round 4

Round 5

Round 6

Q1

Q2

Q3

Q4

Q5

Q6

Q7

Q8

Q9

Q10

Answers

Round 7

Round 8

Round 9

Round 10

Bonus Round

# Round 6 — Birds — Answer 3

Welcome to  
Quarantine Trivia  
IX!

## Question

Which extant species of bird has the longest wingspan?

Round 1

Round 2

Round 3

Round 4

Round 5

Round 6

Q1

Q2

Q3

Q4

Q5

Q6

Q7

Q8

Q9

Q10

Answers

Round 7

Round 8

Round 9

Round 10

Bonus Round



# Round 6 — Birds — Answer 3

Welcome to  
Quarantine Trivia  
IX!

## Question

Which extant species of bird has the longest wingspan?

## Answer

Albatross /  
Wandering  
albatross



Round 1

Round 2

Round 3

Round 4

Round 5

Round 6

Q1

Q2

Q3

Q4

Q5

Q6

Q7

Q8

Q9

Q10

Answers

Round 7

Round 8

Round 9

Round 10

Bonus Round

# Round 6 — Birds — Answer 4

Welcome to  
Quarantine Trivia  
IX!

## Question

What is New Zealand's national bird?

Round 1

Round 2

Round 3

Round 4

Round 5

Round 6

Q1

Q2

Q3

Q4

Q5

Q6

Q7

Q8

Q9

Q10

Answers

Round 7

Round 8

Round 9

Round 10

Bonus Round

## Round 6 — Birds — Answer 4

Welcome to  
Quarantine Trivia  
IX!

### Question

What is New Zealand's national bird?

### Answer

The kiwi



Round 1

Round 2

Round 3

Round 4

Round 5

Round 6

Q1

Q2

Q3

Q4

Q5

Q6

Q7

Q8

Q9

Q10

Answers

Round 7

Round 8

Round 9

Round 10

Bonus Round

# Round 6 — Birds — Answer 5

Welcome to  
Quarantine Trivia  
IX!

## Question

Which species of American bird went extinct in the wild in 1987 but, in a remarkable conservation success story, was bred in captivity and eventually released back into the wild?

Round 1

Round 2

Round 3

Round 4

Round 5

Round 6

Q1

Q2

Q3

Q4

Q5

Q6

Q7

Q8

Q9

Q10

Answers

Round 7

Round 8

Round 9

Round 10

Bonus Round

# Round 6 — Birds — Answer 5

Welcome to  
Quarantine Trivia  
IX!

## Question

Which species of American bird went extinct in the wild in 1987 but, in a remarkable conservation success story, was bred in captivity and eventually released back into the wild?

## Answer

California condor



Round 1

Round 2

Round 3

Round 4

Round 5

Round 6

Q1

Q2

Q3

Q4

Q5

Q6

Q7

Q8

Q9

Q10

Answers

Round 7

Round 8

Round 9

Round 10

Bonus Round

# Round 6 — Birds — Answer 6

Welcome to  
Quarantine Trivia  
IX!

## Question

What is the word for a baby swan?

Round 1

Round 2

Round 3

Round 4

Round 5

Round 6

Q1

Q2

Q3

Q4

Q5

Q6

Q7

Q8

Q9

Q10

Answers

Round 7

Round 8

Round 9

Round 10

Bonus Round

# Round 6 — Birds — Answer 6

Welcome to  
Quarantine Trivia  
IX!

## Question

What is the word for a baby swan?

## Answer

A cygnet



Round 1

Round 2

Round 3

Round 4

Round 5

Round 6

Q1

Q2

Q3

Q4

Q5

Q6

Q7

Q8

Q9

Q10

Answers

Round 7

Round 8

Round 9

Round 10

Bonus Round

# Round 6 — Birds — Answer 7

Welcome to  
Quarantine Trivia  
IX!

## Question

What was the name of the gray parrot that could count up to six, identify shapes and colors by name, say over 100 English words, and is the only non-human to have ever asked a question?

Round 1

Round 2

Round 3

Round 4

Round 5

Round 6

Q1

Q2

Q3

Q4

Q5

Q6

Q7

Q8

Q9

Q10

Answers

Round 7

Round 8

Round 9

Round 10

Bonus Round



# Round 6 — Birds — Answer 7

Welcome to  
Quarantine Trivia  
IX!

## Question

What was the name of the gray parrot that could count up to six, identify shapes and colors by name, say over 100 English words, and is the only non-human to have ever asked a question?

## Answer

Alex (after seeing himself in a mirror, he asked what color he was)



Round 1

Round 2

Round 3

Round 4

Round 5

Round 6

Q1

Q2

Q3

Q4

Q5

Q6

Q7

Q8

Q9

Q10

Answers

Round 7

Round 8

Round 9

Round 10

Bonus Round

# Round 6 — Birds — Answer 8

Welcome to  
Quarantine Trivia  
IX!

## Question

A murder is a group of crows and a parliament is a group of owls. A “flamboyance” is a group of what kind of birds?

Round 1

Round 2

Round 3

Round 4

Round 5

Round 6

Q1

Q2

Q3

Q4

Q5

Q6

Q7

Q8

Q9

Q10

Answers

Round 7

Round 8

Round 9

Round 10

Bonus Round

## Round 6 — Birds — Answer 8

Welcome to  
Quarantine Trivia  
IX!

### Question

A murder is a group of crows and a parliament is a group of owls. A “flamboyance” is a group of what kind of birds?

### Answer

Flamingos



Round 1

Round 2

Round 3

Round 4

Round 5

Round 6

Q1

Q2

Q3

Q4

Q5

Q6

Q7

Q8

Q9

Q10

Answers

Round 7

Round 8

Round 9

Round 10

Bonus Round

# Round 6 — Birds — Answer 9

Welcome to  
Quarantine Trivia  
IX!

## Question

What kind of birds, known for being difficult to hunt due to their camouflage and erratic flight, lent their name to a word synonymous with “marksman”?

Round 1

Round 2

Round 3

Round 4

Round 5

Round 6

Q1

Q2

Q3

Q4

Q5

Q6

Q7

Q8

Q9

Q10

Answers

Round 7

Round 8

Round 9

Round 10

Bonus Round

## Round 6 — Birds — Answer 9

Welcome to  
Quarantine Trivia  
IX!

### Question

What kind of birds, known for being difficult to hunt due to their camouflage and erratic flight, lent their name to a word synonymous with “marksman”?

### Answer

Snipes (“sniping” originally meant snipe-hunting)



Round 1

Round 2

Round 3

Round 4

Round 5

Round 6

Q1

Q2

Q3

Q4

Q5

Q6

Q7

Q8

Q9

Q10

Answers

Round 7

Round 8

Round 9

Round 10

Bonus Round

# Round 6 — Birds — Answer 10

Welcome to  
Quarantine Trivia  
IX!

## Question

Where in a bird's body is/are its wishbone(s) located?

Round 1

Round 2

Round 3

Round 4

Round 5

Round 6

Q1

Q2

Q3

Q4

Q5

Q6

Q7

Q8

Q9

Q10

Answers

Round 7

Round 8

Round 9

Round 10

Bonus Round

## Round 6 — Birds — Answer 10

Welcome to  
Quarantine Trivia  
IX!

### Question

Where in a bird's body is/are its wishbone(s) located?

### Answer

Its chest (there's  
only one)

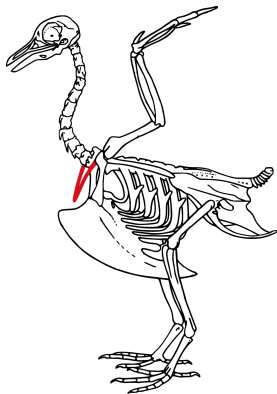

Round 1

Round 2

Round 3

Round 4

Round 5

Round 6

Q1

Q2

Q3

Q4

Q5

Q6

Q7

Q8

Q9

Q10

Answers

Round 7

Round 8

Round 9

Round 10

Bonus Round

Round 1

Round 2

Round 3

Round 4

Round 5

Round 6

**Round 7**

Q1

Q2

Q3

Q4

Q5

Q6

Q7

Q8

Q9

Q10

Answers

Round 8

Round 9

Round 10

Bonus Round

## Round 7

### Native Americans

Please mute yourselves!



# Round 7 — Native Americans — Question 1

Welcome to  
Quarantine Trivia  
IX!

## Question

Name any one of the three tribes that together defeated the U.S. Army forces under Lt. Col. George Custer (known to Native Americans as Long Hair or Yellow Hair) at the Battle of Little Bighorn (known to Native Americans as the Battle of the Greasy Grass) in 1876.

Round 1

Round 2

Round 3

Round 4

Round 5

Round 6

Round 7

Q1

Q2

Q3

Q4

Q5

Q6

Q7

Q8

Q9

Q10

Answers

Round 8

Round 9

Round 10

Bonus Round

# Round 7 — Native Americans — Question 2

Welcome to  
Quarantine Trivia  
IX!

## Question

What famous Lakota Sioux Chief late in life became a cast member of Buffalo Bill's Wild West show?

Round 1

Round 2

Round 3

Round 4

Round 5

Round 6

Round 7

Q1

**Q2**

Q3

Q4

Q5

Q6

Q7

Q8

Q9

Q10

Answers

Round 8

Round 9

Round 10

Bonus Round

# Round 7 — Native Americans — Question 3

Welcome to  
Quarantine Trivia  
IX!

## Question

What is the name of the activist Native American who became the first national director of the American Indian Movement (AIM) in 1970 and who led AIM's takeover of Mount Rushmore in 1971?

Round 1

Round 2

Round 3

Round 4

Round 5

Round 6

Round 7

Q1

Q2

**Q3**

Q4

Q5

Q6

Q7

Q8

Q9

Q10

Answers

Round 8

Round 9

Round 10

Bonus Round

# Round 7 — Native Americans — Question 4

Welcome to  
Quarantine Trivia  
IX!

## Question

What is the name of the Lakota Sioux medicine man who converted to Catholicism in later life and who is presently being considered for sainthood by the Vatican?

Round 1

Round 2

Round 3

Round 4

Round 5

Round 6

Round 7

Q1

Q2

Q3

**Q4**

Q5

Q6

Q7

Q8

Q9

Q10

Answers

Round 8

Round 9

Round 10

Bonus Round

# Round 7 — Native Americans — Question 5

Welcome to  
Quarantine Trivia  
IX!

## Question

During the period from 1830 to 1850, Native Americans in the southeast were forcibly relocated from their ancestral lands to “Indian territory” west of the Mississippi pursuant to authority granted by the federal Indian Removal Act. What is the name given to that forced relocation?

Round 1

Round 2

Round 3

Round 4

Round 5

Round 6

Round 7

Q1

Q2

Q3

Q4

Q5

Q6

Q7

Q8

Q9

Q10

Answers

Round 8

Round 9

Round 10

Bonus Round

# Round 7 — Native Americans — Question 6

Welcome to  
Quarantine Trivia  
IX!

## Question

What is the name of the religious ceremony that originated among Native Americans in the Great Plains and in which participants sit in a hut-like structure heated to a high temperature with hot rocks?

Round 1

Round 2

Round 3

Round 4

Round 5

Round 6

Round 7

Q1

Q2

Q3

Q4

Q5

**Q6**

Q7

Q8

Q9

Q10

Answers

Round 8

Round 9

Round 10

Bonus Round

# Round 7 — Native Americans — Question 7

Welcome to  
Quarantine Trivia  
IX!

## Question

What is the name of the Native American writer who wrote *Smoke Signals* and *Reservation Blues*?

Round 1

Round 2

Round 3

Round 4

Round 5

Round 6

Round 7

Q1

Q2

Q3

Q4

Q5

Q6

**Q7**

Q8

Q9

Q10

Answers

Round 8

Round 9

Round 10

Bonus Round

# Round 7 — Native Americans — Question 8

Welcome to  
Quarantine Trivia  
IX!

## Question

What is the largest Native American tribe today?

Round 1

Round 2

Round 3

Round 4

Round 5

Round 6

Round 7

Q1

Q2

Q3

Q4

Q5

Q6

Q7

**Q8**

Q9

Q10

Answers

Round 8

Round 9

Round 10

Bonus Round



# Round 7 — Native Americans — Question 9

Welcome to  
Quarantine Trivia  
IX!

## Question

What is the name given to the events at which Native Americans meet to dance, sing, socialize, and honor their cultures?

Round 1

Round 2

Round 3

Round 4

Round 5

Round 6

Round 7

Q1

Q2

Q3

Q4

Q5

Q6

Q7

Q8

**Q9**

Q10

Answers

Round 8

Round 9

Round 10

Bonus Round

# Round 7 — Native Americans — Question 10

Welcome to  
Quarantine Trivia  
IX!

## Question

Of what tribe was the great Native American leader and medicine man Geronimo?

Round 1

Round 2

Round 3

Round 4

Round 5

Round 6

Round 7

Q1

Q2

Q3

Q4

Q5

Q6

Q7

Q8

Q9

**Q10**

Answers

Round 8

Round 9

Round 10

Bonus Round

Round 1

Round 2

Round 3

Round 4

Round 5

Round 6

Round 7

Q1

Q2

Q3

Q4

Q5

Q6

Q7

Q8

Q9

Q10

**Answers**

Round 8

Round 9

Round 10

Bonus Round

## Round 7 Answers

Unmute yourselves!

# Round 7 — Native Americans — Answer 1

Welcome to  
Quarantine Trivia  
IX!

## Question

Name any one of the three tribes that together defeated the U.S. Army forces under Lt. Col. George Custer (known to Native Americans as Long Hair or Yellow Hair) at the Battle of Little Bighorn (known to Native Americans as the Battle of the Greasy Grass) in 1876.

Round 1

Round 2

Round 3

Round 4

Round 5

Round 6

Round 7

Q1

Q2

Q3

Q4

Q5

Q6

Q7

Q8

Q9

Q10

Answers

Round 8

Round 9

Round 10

Bonus Round

# Round 7 — Native Americans — Answer 1

Welcome to  
Quarantine Trivia  
IX!

## Question

Name any one of the three tribes that together defeated the U.S. Army forces under Lt. Col. George Custer (known to Native Americans as Long Hair or Yellow Hair) at the Battle of Little Bighorn (known to Native Americans as the Battle of the Greasy Grass) in 1876.

## Answer

Lakota Sioux,  
Northern  
Cheyenne and  
Arapaho



Round 1

Round 2

Round 3

Round 4

Round 5

Round 6

Round 7

Q1

Q2

Q3

Q4

Q5

Q6

Q7

Q8

Q9

Q10

Answers

Round 8

Round 9

Round 10

Bonus Round

# Round 7 — Native Americans — Answer 2

Welcome to  
Quarantine Trivia  
IX!

## Question

What famous Lakota Sioux Chief late in life became a cast member of Buffalo Bill's Wild West show?

Round 1

Round 2

Round 3

Round 4

Round 5

Round 6

Round 7

Q1

Q2

Q3

Q4

Q5

Q6

Q7

Q8

Q9

Q10

Answers

Round 8

Round 9

Round 10

Bonus Round

# Round 7 — Native Americans — Answer 2

Welcome to  
Quarantine Trivia  
IX!

## Question

What famous Lakota Sioux Chief late in life became a cast member of Buffalo Bill's Wild West show?

## Answer

Sitting Bull



Round 1

Round 2

Round 3

Round 4

Round 5

Round 6

Round 7

Q1

Q2

Q3

Q4

Q5

Q6

Q7

Q8

Q9

Q10

Answers

Round 8

Round 9

Round 10

Bonus Round

# Round 7 — Native Americans — Answer 3

Welcome to  
Quarantine Trivia  
IX!

## Question

What is the name of the activist Native American who became the first national director of the American Indian Movement (AIM) in 1970 and who led AIM's takeover of Mount Rushmore in 1971?

Round 1

Round 2

Round 3

Round 4

Round 5

Round 6

Round 7

Q1

Q2

Q3

Q4

Q5

Q6

Q7

Q8

Q9

Q10

Answers

Round 8

Round 9

Round 10

Bonus Round



# Round 7 — Native Americans — Answer 3

Welcome to  
Quarantine Trivia  
IX!

## Question

What is the name of the activist Native American who became the first national director of the American Indian Movement (AIM) in 1970 and who led AIM's takeover of Mount Rushmore in 1971?

## Answer

Russel Means /  
Brave Eagle /  
Wanbli Ohitika

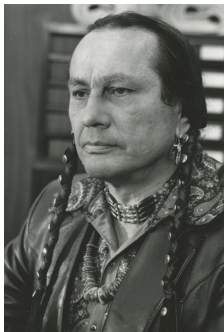

Round 1

Round 2

Round 3

Round 4

Round 5

Round 6

Round 7

Q1

Q2

Q3

Q4

Q5

Q6

Q7

Q8

Q9

Q10

Answers

Round 8

Round 9

Round 10

Bonus Round

# Round 7 — Native Americans — Answer 4

Welcome to  
Quarantine Trivia  
IX!

## Question

What is the name of the Lakota Sioux medicine man who converted to Catholicism in later life and who is presently being considered for sainthood by the Vatican?

Round 1

Round 2

Round 3

Round 4

Round 5

Round 6

Round 7

Q1

Q2

Q3

Q4

Q5

Q6

Q7

Q8

Q9

Q10

Answers

Round 8

Round 9

Round 10

Bonus Round

# Round 7 — Native Americans — Answer 4

Welcome to  
Quarantine Trivia  
IX!

## Question

What is the name of the Lakota Sioux medicine man who converted to Catholicism in later life and who is presently being considered for sainthood by the Vatican?

## Answer

Black Elk /  
Nicholas Black Elk



Round 1

Round 2

Round 3

Round 4

Round 5

Round 6

Round 7

Q1

Q2

Q3

Q4

Q5

Q6

Q7

Q8

Q9

Q10

Answers

Round 8

Round 9

Round 10

Bonus Round

# Round 7 — Native Americans — Answer 5

Welcome to  
Quarantine Trivia  
IX!

## Question

During the period from 1830 to 1850, Native Americans in the southeast were forcibly relocated from their ancestral lands to “Indian territory” west of the Mississippi pursuant to authority granted by the federal Indian Removal Act. What is the name given to that forced relocation?

Round 1

Round 2

Round 3

Round 4

Round 5

Round 6

Round 7

Q1

Q2

Q3

Q4

Q5

Q6

Q7

Q8

Q9

Q10

Answers

Round 8

Round 9

Round 10

Bonus Round

# Round 7 — Native Americans — Answer 5

Welcome to  
Quarantine Trivia  
IX!

## Question

During the period from 1830 to 1850, Native Americans in the southeast were forcibly relocated from their ancestral lands to “Indian territory” west of the Mississippi pursuant to authority granted by the federal Indian Removal Act. What is the name given to that forced relocation?

## Answer

The Trail of Tears



Round 1

Round 2

Round 3

Round 4

Round 5

Round 6

Round 7

Q1

Q2

Q3

Q4

Q5

Q6

Q7

Q8

Q9

Q10

Answers

Round 8

Round 9

Round 10

Bonus Round

# Round 7 — Native Americans — Answer 6

Welcome to  
Quarantine Trivia  
IX!

## Question

What is the name of the religious ceremony that originated among Native Americans in the Great Plains and in which participants sit in a hut-like structure heated to a high temperature with hot rocks?

Round 1

Round 2

Round 3

Round 4

Round 5

Round 6

Round 7

Q1

Q2

Q3

Q4

Q5

Q6

Q7

Q8

Q9

Q10

Answers

Round 8

Round 9

Round 10

Bonus Round

# Round 7 — Native Americans — Answer 6

Welcome to  
Quarantine Trivia  
IX!

## Question

What is the name of the religious ceremony that originated among Native Americans in the Great Plains and in which participants sit in a hut-like structure heated to a high temperature with hot rocks?

## Answer

Sweat lodge ceremony / sweat lodge



Round 1

Round 2

Round 3

Round 4

Round 5

Round 6

Round 7

Q1

Q2

Q3

Q4

Q5

Q6

Q7

Q8

Q9

Q10

Answers

Round 8

Round 9

Round 10

Bonus Round

# Round 7 — Native Americans — Answer 7

Welcome to  
Quarantine Trivia  
IX!

## Question

What is the name of the Native American writer who wrote *Smoke Signals* and *Reservation Blues*?

Round 1

Round 2

Round 3

Round 4

Round 5

Round 6

Round 7

Q1

Q2

Q3

Q4

Q5

Q6

Q7

Q8

Q9

Q10

Answers

Round 8

Round 9

Round 10

Bonus Round



# Round 7 — Native Americans — Answer 7

Welcome to  
Quarantine Trivia  
IX!

## Question

What is the name of the Native American writer who wrote *Smoke Signals* and *Reservation Blues*?

## Answer

Sherman Alexie



Round 1

Round 2

Round 3

Round 4

Round 5

Round 6

Round 7

Q1

Q2

Q3

Q4

Q5

Q6

Q7

Q8

Q9

Q10

Answers

Round 8

Round 9

Round 10

Bonus Round

# Round 7 — Native Americans — Answer 8

Welcome to  
Quarantine Trivia  
IX!

## Question

What is the largest Native American tribe today?

Round 1

Round 2

Round 3

Round 4

Round 5

Round 6

Round 7

Q1

Q2

Q3

Q4

Q5

Q6

Q7

Q8

Q9

Q10

**Answers**

Round 8

Round 9

Round 10

Bonus Round

# Round 7 — Native Americans — Answer 8

Welcome to  
Quarantine Trivia  
IX!

## Question

What is the largest Native American tribe today?

## Answer

The Cherokee



Round 1

Round 2

Round 3

Round 4

Round 5

Round 6

Round 7

Q1

Q2

Q3

Q4

Q5

Q6

Q7

Q8

Q9

Q10

Answers

Round 8

Round 9

Round 10

Bonus Round

# Round 7 — Native Americans — Answer 9

Welcome to  
Quarantine Trivia  
IX!

## Question

What is the name given to the events at which Native Americans meet to dance, sing, socialize, and honor their cultures?

Round 1

Round 2

Round 3

Round 4

Round 5

Round 6

Round 7

Q1

Q2

Q3

Q4

Q5

Q6

Q7

Q8

Q9

Q10

Answers

Round 8

Round 9

Round 10

Bonus Round

# Round 7 — Native Americans — Answer 9

Welcome to  
Quarantine Trivia  
IX!

## Question

What is the name given to the events at which Native Americans meet to dance, sing, socialize, and honor their cultures?

## Answer

Pow wows



Round 1

Round 2

Round 3

Round 4

Round 5

Round 6

Round 7

Q1

Q2

Q3

Q4

Q5

Q6

Q7

Q8

Q9

Q10

Answers

Round 8

Round 9

Round 10

Bonus Round

# Round 7 — Native Americans — Answer 10

Welcome to  
Quarantine Trivia  
IX!

## Question

Of what tribe was the great Native American leader and medicine man Geronimo?

Round 1

Round 2

Round 3

Round 4

Round 5

Round 6

Round 7

Q1

Q2

Q3

Q4

Q5

Q6

Q7

Q8

Q9

Q10

Answers

Round 8

Round 9

Round 10

Bonus Round



Round 1

Round 2

Round 3

Round 4

Round 5

Round 6

Round 7

**Round 8**

Q1

Q2

Q3

Q4

Q5

Q6

Q7

Q8

Q9

Q10

Answers

Round 9

Round 10

Bonus Round

## Round 8

The home of ...

Please mute yourselves!



# Round 8 — The home of ... — Question 1

Welcome to  
Quarantine Trivia  
IX!

## Question

Burger King

Round 1

Round 2

Round 3

Round 4

Round 5

Round 6

Round 7

Round 8

Q1

Q2

Q3

Q4

Q5

Q6

Q7

Q8

Q9

Q10

Answers

Round 9

Round 10

Bonus Round

# Round 8 — The home of ... — Question 2

Welcome to  
Quarantine Trivia  
IX!

## Question

Delphi in ancient Greece

Round 1

Round 2

Round 3

Round 4

Round 5

Round 6

Round 7

Round 8

Q1

**Q2**

Q3

Q4

Q5

Q6

Q7

Q8

Q9

Q10

Answers

Round 9

Round 10

Bonus Round

# Round 8 — The home of ... — Question 3

Welcome to  
Quarantine Trivia  
IX!

## Question

Camden Yards

Round 1

Round 2

Round 3

Round 4

Round 5

Round 6

Round 7

Round 8

Q1

Q2

**Q3**

Q4

Q5

Q6

Q7

Q8

Q9

Q10

Answers

Round 9

Round 10

Bonus Round

# Round 8 — The home of ... — Question 4

Welcome to  
Quarantine Trivia  
IX!

## Question

Elba Island, 1814–1815

Round 1

Round 2

Round 3

Round 4

Round 5

Round 6

Round 7

Round 8

Q1

Q2

Q3

**Q4**

Q5

Q6

Q7

Q8

Q9

Q10

Answers

Round 9

Round 10

Bonus Round

# Round 8 — The home of ... — Question 5

Welcome to  
Quarantine Trivia  
IX!

## Question

Michie Stadium

Round 1

Round 2

Round 3

Round 4

Round 5

Round 6

Round 7

Round 8

Q1

Q2

Q3

Q4

**Q5**

Q6

Q7

Q8

Q9

Q10

Answers

Round 9

Round 10

Bonus Round

# Round 8 — The home of ... — Question 6

Welcome to  
Quarantine Trivia  
IX!

## Question

Realtor.com

Round 1

Round 2

Round 3

Round 4

Round 5

Round 6

Round 7

Round 8

Q1

Q2

Q3

Q4

Q5

**Q6**

Q7

Q8

Q9

Q10

Answers

Round 9

Round 10

Bonus Round

# Round 8 — The home of ... — Question 7

Welcome to  
Quarantine Trivia  
IX!

## Question

Bentonville, Arkansas

Round 1

Round 2

Round 3

Round 4

Round 5

Round 6

Round 7

Round 8

Q1

Q2

Q3

Q4

Q5

Q6

**Q7**

Q8

Q9

Q10

Answers

Round 9

Round 10

Bonus Round

# Round 8 — The home of ... — Question 8

Welcome to  
Quarantine Trivia  
IX!

## Question

Riverside, Iowa

Round 1

Round 2

Round 3

Round 4

Round 5

Round 6

Round 7

Round 8

Q1

Q2

Q3

Q4

Q5

Q6

Q7

**Q8**

Q9

Q10

Answers

Round 9

Round 10

Bonus Round



# Round 8 — The home of ... — Question 9

Welcome to  
Quarantine Trivia  
IX!

## Question

Corbin, Kentucky

Round 1

Round 2

Round 3

Round 4

Round 5

Round 6

Round 7

Round 8

Q1

Q2

Q3

Q4

Q5

Q6

Q7

Q8

**Q9**

Q10

Answers

Round 9

Round 10

Bonus Round

# Round 8 — The home of ... — Question 10

Welcome to  
Quarantine Trivia  
IX!

## Question

Williamsport, Pennsylvania

Round 1

Round 2

Round 3

Round 4

Round 5

Round 6

Round 7

Round 8

Q1

Q2

Q3

Q4

Q5

Q6

Q7

Q8

Q9

**Q10**

Answers

Round 9

Round 10

Bonus Round

Round 1

Round 2

Round 3

Round 4

Round 5

Round 6

Round 7

Round 8

Q1

Q2

Q3

Q4

Q5

Q6

Q7

Q8

Q9

Q10

**Answers**

Round 9

Round 10

Bonus Round

## Round 8

### Answers

Unmute yourselves!

# Round 8 — The home of ... — Answer 1

Welcome to  
Quarantine Trivia  
IX!

## Question

Burger King

Round 1

Round 2

Round 3

Round 4

Round 5

Round 6

Round 7

Round 8

Q1

Q2

Q3

Q4

Q5

Q6

Q7

Q8

Q9

Q10

**Answers**

Round 9

Round 10

Bonus Round

# Round 8 — The home of ... — Answer 1

Welcome to  
Quarantine Trivia  
IX!

## Question

Burger King

## Answer

The Whopper



Round 1

Round 2

Round 3

Round 4

Round 5

Round 6

Round 7

Round 8

Q1

Q2

Q3

Q4

Q5

Q6

Q7

Q8

Q9

Q10

Answers

Round 9

Round 10

Bonus Round

# Round 8 — The home of ... — Answer 2

Welcome to  
Quarantine Trivia  
IX!

## Question

Delphi in ancient Greece

Round 1

Round 2

Round 3

Round 4

Round 5

Round 6

Round 7

Round 8

Q1

Q2

Q3

Q4

Q5

Q6

Q7

Q8

Q9

Q10

**Answers**

Round 9

Round 10

Bonus Round

# Round 8 — The home of ... — Answer 2

Welcome to  
Quarantine Trivia  
IX!

## Question

Delphi in ancient Greece

## Answer

The Oracle / The  
Delphic Oracle



Round 1

Round 2

Round 3

Round 4

Round 5

Round 6

Round 7

Round 8

Q1

Q2

Q3

Q4

Q5

Q6

Q7

Q8

Q9

Q10

Answers

Round 9

Round 10

Bonus Round

# Round 8 — The home of ... — Answer 3

Welcome to  
Quarantine Trivia  
IX!

## Question

Camden Yards

Round 1

Round 2

Round 3

Round 4

Round 5

Round 6

Round 7

Round 8

Q1

Q2

Q3

Q4

Q5

Q6

Q7

Q8

Q9

Q10

**Answers**

Round 9

Round 10

Bonus Round



# Round 8 — The home of ... — Answer 3

Welcome to  
Quarantine Trivia  
IX!

## Question

Camden Yards

## Answer

The Baltimore  
Orioles



Round 1

Round 2

Round 3

Round 4

Round 5

Round 6

Round 7

Round 8

Q1

Q2

Q3

Q4

Q5

Q6

Q7

Q8

Q9

Q10

Answers

Round 9

Round 10

Bonus Round

# Round 8 — The home of ... — Answer 4

Welcome to  
Quarantine Trivia  
IX!

## Question

Elba Island, 1814–1815

Round 1

Round 2

Round 3

Round 4

Round 5

Round 6

Round 7

Round 8

Q1

Q2

Q3

Q4

Q5

Q6

Q7

Q8

Q9

Q10

**Answers**

Round 9

Round 10

Bonus Round

# Round 8 — The home of ... — Answer 4

Welcome to  
Quarantine Trivia  
IX!

## Question

Elba Island, 1814–1815

## Answer

Napoleon



Round 1

Round 2

Round 3

Round 4

Round 5

Round 6

Round 7

Round 8

Q1

Q2

Q3

Q4

Q5

Q6

Q7

Q8

Q9

Q10

Answers

Round 9

Round 10

Bonus Round

# Round 8 — The home of ... — Answer 5

Welcome to  
Quarantine Trivia  
IX!

## Question

Michie Stadium

Round 1

Round 2

Round 3

Round 4

Round 5

Round 6

Round 7

Round 8

Q1

Q2

Q3

Q4

Q5

Q6

Q7

Q8

Q9

Q10

**Answers**

Round 9

Round 10

Bonus Round

# Round 8 — The home of ... — Answer 5

Welcome to  
Quarantine Trivia  
IX!

## Question

Michie Stadium

## Answer

The Army football  
team / The Black  
Knights / The  
Cadets



Round 1

Round 2

Round 3

Round 4

Round 5

Round 6

Round 7

Round 8

Q1

Q2

Q3

Q4

Q5

Q6

Q7

Q8

Q9

Q10

Answers

Round 9

Round 10

Bonus Round

# Round 8 — The home of ... — Answer 6

Welcome to  
Quarantine Trivia  
IX!

Question

Realtor.com

Round 1

Round 2

Round 3

Round 4

Round 5

Round 6

Round 7

Round 8

Q1

Q2

Q3

Q4

Q5

Q6

Q7

Q8

Q9

Q10

**Answers**

Round 9

Round 10

Bonus Round

# Round 8 — The home of ... — Answer 6

Welcome to  
Quarantine Trivia  
IX!

## Question

Realtor.com

## Answer

“The Home of Home Search”

Round 1

Round 2

Round 3

Round 4

Round 5

Round 6

Round 7

Round 8

Q1

Q2

Q3

Q4

Q5

Q6

Q7

Q8

Q9

Q10

Answers

Round 9

Round 10

Bonus Round

# Round 8 — The home of ... — Answer 7

Welcome to  
Quarantine Trivia  
IX!

## Question

Bentonville, Arkansas

Round 1

Round 2

Round 3

Round 4

Round 5

Round 6

Round 7

Round 8

Q1

Q2

Q3

Q4

Q5

Q6

Q7

Q8

Q9

Q10

**Answers**

Round 9

Round 10

Bonus Round



# Round 8 — The home of ... — Answer 7

Welcome to  
Quarantine Trivia  
IX!

## Question

Bentonville, Arkansas

## Answer

Walmart



Round 1

Round 2

Round 3

Round 4

Round 5

Round 6

Round 7

Round 8

Q1

Q2

Q3

Q4

Q5

Q6

Q7

Q8

Q9

Q10

Answers

Round 9

Round 10

Bonus Round

# Round 8 — The home of ... — Answer 8

Welcome to  
Quarantine Trivia  
IX!

## Question

Riverside, Iowa

Round 1

Round 2

Round 3

Round 4

Round 5

Round 6

Round 7

Round 8

Q1

Q2

Q3

Q4

Q5

Q6

Q7

Q8

Q9

Q10

**Answers**

Round 9

Round 10

Bonus Round

# Round 8 — The home of ... — Answer 8

Welcome to  
Quarantine Trivia  
IX!

## Question

Riverside, Iowa

## Answer

Captain James T.  
Kirk of the  
Starship  
Enterprise, who  
will be born there  
on March 22,  
2228



Round 1

Round 2

Round 3

Round 4

Round 5

Round 6

Round 7

Round 8

Q1

Q2

Q3

Q4

Q5

Q6

Q7

Q8

Q9

Q10

Answers

Round 9

Round 10

Bonus Round

# Round 8 — The home of ... — Answer 9

Welcome to  
Quarantine Trivia  
IX!

## Question

Corbin, Kentucky

Round 1

Round 2

Round 3

Round 4

Round 5

Round 6

Round 7

Round 8

Q1

Q2

Q3

Q4

Q5

Q6

Q7

Q8

Q9

Q10

**Answers**

Round 9

Round 10

Bonus Round

# Round 8 — The home of ... — Answer 9

Welcome to  
Quarantine Trivia  
IX!

## Question

Corbin, Kentucky

## Answer

Kentucky Fried  
Chicken / KFC



Round 1

Round 2

Round 3

Round 4

Round 5

Round 6

Round 7

Round 8

Q1

Q2

Q3

Q4

Q5

Q6

Q7

Q8

Q9

Q10

Answers

Round 9

Round 10

Bonus Round

# Round 8 — The home of ... — Answer 10

Welcome to  
Quarantine Trivia  
IX!

## Question

Williamsport, Pennsylvania

Round 1

Round 2

Round 3

Round 4

Round 5

Round 6

Round 7

Round 8

Q1

Q2

Q3

Q4

Q5

Q6

Q7

Q8

Q9

Q10

**Answers**

Round 9

Round 10

Bonus Round

# Round 8 — The home of ... — Answer 10

Welcome to  
Quarantine Trivia  
IX!

## Question

Williamsport, Pennsylvania

## Answer

The Little League  
World Series



Round 1

Round 2

Round 3

Round 4

Round 5

Round 6

Round 7

Round 8

Q1

Q2

Q3

Q4

Q5

Q6

Q7

Q8

Q9

Q10

Answers

Round 9

Round 10

Bonus Round

Round 1

Round 2

Round 3

Round 4

Round 5

Round 6

Round 7

Round 8

**Round 9**

Q1

Q2

Q3

Q4

Q5

Q6

Q7

Q8

Q9

Q10

Answers

Round 10

Bonus Round

## Round 9

### Wonders of Engineering

Please mute yourselves!



# Round 9 — Wonders of Engineering — Question 1

Welcome to  
Quarantine Trivia  
IX!

## Question

What is the longest suspension bridge in the U.S.?

Round 1

Round 2

Round 3

Round 4

Round 5

Round 6

Round 7

Round 8

Round 9

Q1

Q2

Q3

Q4

Q5

Q6

Q7

Q8

Q9

Q10

Answers

Round 10

Bonus Round

# Round 9 — Wonders of Engineering — Question 2

Welcome to  
Quarantine Trivia  
IX!

## Question

What is the name of the Roman aqueduct built during the reign of the Emperor Augustus that was restored during the Renaissance and that still serves Rome as an aqueduct today?

Round 1

Round 2

Round 3

Round 4

Round 5

Round 6

Round 7

Round 8

Round 9

Q1

**Q2**

Q3

Q4

Q5

Q6

Q7

Q8

Q9

Q10

Answers

Round 10

Bonus Round

# Round 9 — Wonders of Engineering — Question 3

Welcome to  
Quarantine Trivia  
IX!

## Question

What is the name of the longest bridge over water in the world?

Round 1

Round 2

Round 3

Round 4

Round 5

Round 6

Round 7

Round 8

Round 9

Q1

Q2

**Q3**

Q4

Q5

Q6

Q7

Q8

Q9

Q10

Answers

Round 10

Bonus Round

# Round 9 — Wonders of Engineering — Question 4

Welcome to  
Quarantine Trivia  
IX!

## Question

The driving-in of the “golden spike” in 1869 marked the completion of which American project?

Round 1

Round 2

Round 3

Round 4

Round 5

Round 6

Round 7

Round 8

Round 9

Q1

Q2

Q3

**Q4**

Q5

Q6

Q7

Q8

Q9

Q10

Answers

Round 10

Bonus Round

# Round 9 — Wonders of Engineering — Question 5

Welcome to  
Quarantine Trivia  
IX!

## Question

What is the only substantially intact wonder of the Seven Wonders of the Ancient World?

Round 1

Round 2

Round 3

Round 4

Round 5

Round 6

Round 7

Round 8

Round 9

Q1

Q2

Q3

Q4

**Q5**

Q6

Q7

Q8

Q9

Q10

Answers

Round 10

Bonus Round

# Round 9 — Wonders of Engineering — Question 6

Welcome to  
Quarantine Trivia  
IX!

## Question

To the nearest 250 feet / 76m, how tall is the Burj Khalifa, the tallest building in the world?

Round 1

Round 2

Round 3

Round 4

Round 5

Round 6

Round 7

Round 8

Round 9

Q1

Q2

Q3

Q4

Q5

**Q6**

Q7

Q8

Q9

Q10

Answers

Round 10

Bonus Round

# Round 9 — Wonders of Engineering — Question 7

Welcome to  
Quarantine Trivia  
IX!

## Question

Lake Mead, the reservoir with the largest capacity in the U.S., was formed by the construction of which dam?

Round 1

Round 2

Round 3

Round 4

Round 5

Round 6

Round 7

Round 8

Round 9

Q1

Q2

Q3

Q4

Q5

Q6

**Q7**

Q8

Q9

Q10

Answers

Round 10

Bonus Round

# Round 9 — Wonders of Engineering — Question 8

Welcome to  
Quarantine Trivia  
IX!

## Question

At 85 miles long and almost entirely underground, this aqueduct that serves New York City with water from reservoirs on the west side of the Hudson River is technically the longest tunnel in the world. What is the name of the aqueduct?

Round 1

Round 2

Round 3

Round 4

Round 5

Round 6

Round 7

Round 8

Round 9

Q1

Q2

Q3

Q4

Q5

Q6

Q7

**Q8**

Q9

Q10

Answers

Round 10

Bonus Round



# Round 9 — Wonders of Engineering — Question 9

Welcome to  
Quarantine Trivia  
IX!

## Question

What is the name of the world's largest particle collider (a specific kind of particle accelerator)?

Round 1

Round 2

Round 3

Round 4

Round 5

Round 6

Round 7

Round 8

Round 9

Q1

Q2

Q3

Q4

Q5

Q6

Q7

Q8

**Q9**

Q10

Answers

Round 10

Bonus Round

# Round 9 — Wonders of Engineering — Question 10

Welcome to  
Quarantine Trivia  
IX!

## Question

The International Space Station (ISS), one of the crowning achievements of mankind, is jointly governed by NASA and four other space agencies. Name one of the other space agencies in charge of the ISS.

Round 1

Round 2

Round 3

Round 4

Round 5

Round 6

Round 7

Round 8

Round 9

Q1

Q2

Q3

Q4

Q5

Q6

Q7

Q8

Q9

**Q10**

Answers

Round 10

Bonus Round

Round 1

Round 2

Round 3

Round 4

Round 5

Round 6

Round 7

Round 8

Round 9

Q1

Q2

Q3

Q4

Q5

Q6

Q7

Q8

Q9

Q10

**Answers**

Round 10

Bonus Round

## Round 9

### Answers

Unmute yourselves!

# Round 9 — Wonders of Engineering — Answer 1

Welcome to  
Quarantine Trivia  
IX!

## Question

What is the longest suspension bridge in the U.S.?

Round 1

Round 2

Round 3

Round 4

Round 5

Round 6

Round 7

Round 8

Round 9

Q1

Q2

Q3

Q4

Q5

Q6

Q7

Q8

Q9

Q10

Answers

Round 10

Bonus Round

# Round 9 — Wonders of Engineering — Answer 1

Welcome to  
Quarantine Trivia  
IX!

## Question

What is the longest suspension bridge in the U.S.?

## Answer

The Verrazano-  
Narrows  
Bridge



Round 1

Round 2

Round 3

Round 4

Round 5

Round 6

Round 7

Round 8

Round 9

Q1

Q2

Q3

Q4

Q5

Q6

Q7

Q8

Q9

Q10

Answers

Round 10

Bonus Round

# Round 9 — Wonders of Engineering — Answer 2

Welcome to  
Quarantine Trivia  
IX!

## Question

What is the name of the Roman aqueduct built during the reign of the Emperor Augustus that was restored during the Renaissance and that still serves Rome as an aqueduct today?

Round 1

Round 2

Round 3

Round 4

Round 5

Round 6

Round 7

Round 8

Round 9

Q1

Q2

Q3

Q4

Q5

Q6

Q7

Q8

Q9

Q10

Answers

Round 10

Bonus Round

# Round 9 — Wonders of Engineering — Answer 2

Welcome to  
Quarantine Trivia  
IX!

## Question

What is the name of the Roman aqueduct built during the reign of the Emperor Augustus that was restored during the Renaissance and that still serves Rome as an aqueduct today?

## Answer

Acqua Virgo /  
Acqua Vergine /  
Virgo or Vergine  
Aqueduct



Round 1

Round 2

Round 3

Round 4

Round 5

Round 6

Round 7

Round 8

Round 9

Q1

Q2

Q3

Q4

Q5

Q6

Q7

Q8

Q9

Q10

Answers

Round 10

Bonus Round

# Round 9 — Wonders of Engineering — Answer 3

Welcome to  
Quarantine Trivia  
IX!

## Question

What is the name of the longest bridge over water in the world?

Round 1

Round 2

Round 3

Round 4

Round 5

Round 6

Round 7

Round 8

Round 9

Q1

Q2

Q3

Q4

Q5

Q6

Q7

Q8

Q9

Q10

Answers

Round 10

Bonus Round



# Round 9 — Wonders of Engineering — Answer 3

Welcome to  
Quarantine Trivia  
IX!

## Question

What is the name of the longest bridge over water in the world?

## Answer

The Lake  
Pontchartrain  
Causeway



Round 1

Round 2

Round 3

Round 4

Round 5

Round 6

Round 7

Round 8

Round 9

Q1

Q2

Q3

Q4

Q5

Q6

Q7

Q8

Q9

Q10

Answers

Round 10

Bonus Round

# Round 9 — Wonders of Engineering — Answer 4

Welcome to  
Quarantine Trivia  
IX!

## Question

The driving-in of the “golden spike” in 1869 marked the completion of which American project?

Round 1

Round 2

Round 3

Round 4

Round 5

Round 6

Round 7

Round 8

Round 9

Q1

Q2

Q3

Q4

Q5

Q6

Q7

Q8

Q9

Q10

Answers

Round 10

Bonus Round

# Round 9 — Wonders of Engineering — Answer 4

Welcome to  
Quarantine Trivia  
IX!

## Question

The driving-in of the “golden spike” in 1869 marked the completion of which American project?

## Answer

The  
Transcontinental  
Railroad



Round 1

Round 2

Round 3

Round 4

Round 5

Round 6

Round 7

Round 8

Round 9

Q1

Q2

Q3

Q4

Q5

Q6

Q7

Q8

Q9

Q10

Answers

Round 10

Bonus Round

# Round 9 — Wonders of Engineering — Answer 5

Welcome to  
Quarantine Trivia  
IX!

## Question

What is the only substantially intact wonder of the Seven Wonders of the Ancient World?

Round 1

Round 2

Round 3

Round 4

Round 5

Round 6

Round 7

Round 8

Round 9

Q1

Q2

Q3

Q4

Q5

Q6

Q7

Q8

Q9

Q10

Answers

Round 10

Bonus Round

# Round 9 — Wonders of Engineering — Answer 5

Welcome to  
Quarantine Trivia  
IX!

## Question

What is the only substantially intact wonder of the Seven Wonders of the Ancient World?

## Answer

The Great  
Pyramid at Giza



Round 1

Round 2

Round 3

Round 4

Round 5

Round 6

Round 7

Round 8

Round 9

Q1

Q2

Q3

Q4

Q5

Q6

Q7

Q8

Q9

Q10

Answers

Round 10

Bonus Round

# Round 9 — Wonders of Engineering — Answer 6

Welcome to  
Quarantine Trivia  
IX!

## Question

To the nearest 250 feet / 76m, how tall is the Burj Khalifa, the tallest building in the world?

Round 1

Round 2

Round 3

Round 4

Round 5

Round 6

Round 7

Round 8

Round 9

Q1

Q2

Q3

Q4

Q5

Q6

Q7

Q8

Q9

Q10

Answers

Round 10

Bonus Round

# Round 9 — Wonders of Engineering — Answer 6

Welcome to  
Quarantine Trivia  
IX!

## Question

To the nearest 250 feet / 76m, how tall is the Burj Khalifa, the tallest building in the world?

## Answer

2,722 feet / 830m  
(2472 feet–2972  
feet / 754m–906m  
will be accepted)



Round 1

Round 2

Round 3

Round 4

Round 5

Round 6

Round 7

Round 8

Round 9

Q1

Q2

Q3

Q4

Q5

Q6

Q7

Q8

Q9

Q10

Answers

Round 10

Bonus Round

# Round 9 — Wonders of Engineering — Answer 7

Welcome to  
Quarantine Trivia  
IX!

## Question

Lake Mead, the reservoir with the largest capacity in the U.S., was formed by the construction of which dam?

Round 1

Round 2

Round 3

Round 4

Round 5

Round 6

Round 7

Round 8

Round 9

Q1

Q2

Q3

Q4

Q5

Q6

Q7

Q8

Q9

Q10

Answers

Round 10

Bonus Round



# Round 9 — Wonders of Engineering — Answer 7

Welcome to  
Quarantine Trivia  
IX!

## Question

Lake Mead, the reservoir with the largest capacity in the U.S., was formed by the construction of which dam?

## Answer

The Hoover Dam



Round 1

Round 2

Round 3

Round 4

Round 5

Round 6

Round 7

Round 8

Round 9

Q1

Q2

Q3

Q4

Q5

Q6

Q7

Q8

Q9

Q10

Answers

Round 10

Bonus Round

# Round 9 — Wonders of Engineering — Answer 8

Welcome to  
Quarantine Trivia  
IX!

## Question

At 85 miles long and almost entirely underground, this aqueduct that serves New York City with water from reservoirs on the west side of the Hudson River is technically the longest tunnel in the world. What is the name of the aqueduct?

Round 1

Round 2

Round 3

Round 4

Round 5

Round 6

Round 7

Round 8

Round 9

Q1

Q2

Q3

Q4

Q5

Q6

Q7

Q8

Q9

Q10

Answers

Round 10

Bonus Round

# Round 9 — Wonders of Engineering — Answer 8

Welcome to  
Quarantine Trivia  
IX!

## Question

At 85 miles long and almost entirely underground, this aqueduct that serves New York City with water from reservoirs on the west side of the Hudson River is technically the longest tunnel in the world. What is the name of the aqueduct?

## Answer

The Delaware  
Aqueduct



Round 1

Round 2

Round 3

Round 4

Round 5

Round 6

Round 7

Round 8

Round 9

Q1

Q2

Q3

Q4

Q5

Q6

Q7

Q8

Q9

Q10

Answers

Round 10

Bonus Round

# Round 9 — Wonders of Engineering — Answer 9

Welcome to  
Quarantine Trivia  
IX!

## Question

What is the name of the world's largest particle collider (a specific kind of particle accelerator)?

Round 1

Round 2

Round 3

Round 4

Round 5

Round 6

Round 7

Round 8

Round 9

Q1

Q2

Q3

Q4

Q5

Q6

Q7

Q8

Q9

Q10

Answers

Round 10

Bonus Round

# Round 9 — Wonders of Engineering — Answer 9

Welcome to  
Quarantine Trivia  
IX!

## Question

What is the name of the world's largest particle collider (a specific kind of particle accelerator)?

## Answer

The Large Hadron Collider / LHC

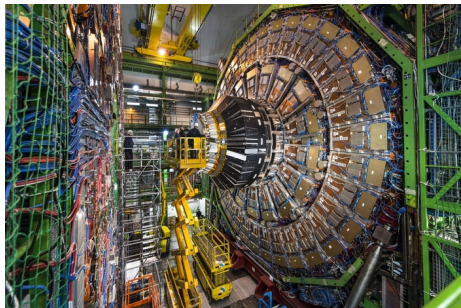

Round 1

Round 2

Round 3

Round 4

Round 5

Round 6

Round 7

Round 8

Round 9

Q1

Q2

Q3

Q4

Q5

Q6

Q7

Q8

Q9

Q10

Answers

Round 10

Bonus Round

# Round 9 — Wonders of Engineering — Answer 10

Welcome to  
Quarantine Trivia  
IX!

## Question

The International Space Station (ISS), one of the crowning achievements of mankind, is jointly governed by NASA and four other space agencies. Name one of the other space agencies in charge of the ISS.

Round 1

Round 2

Round 3

Round 4

Round 5

Round 6

Round 7

Round 8

Round 9

Q1

Q2

Q3

Q4

Q5

Q6

Q7

Q8

Q9

Q10

Answers

Round 10

Bonus Round

# Round 9 — Wonders of Engineering — Answer 10

Welcome to  
Quarantine Trivia  
IX!

## Question

The International Space Station (ISS), one of the crowning achievements of mankind, is jointly governed by NASA and four other space agencies. Name one of the other space agencies in charge of the ISS.

## Answer

Any one of: Roscosmos, JAXA (Japan Aerospace eXploration Agency), ESA (European Space Agency), CSA (Canadian Space Agency)



Round 1

Round 2

Round 3

Round 4

Round 5

Round 6

Round 7

Round 8

Round 9

Q1

Q2

Q3

Q4

Q5

Q6

Q7

Q8

Q9

Q10

Answers

Round 10

Bonus Round

Round 1

Round 2

Round 3

Round 4

Round 5

Round 6

Round 7

Round 8

Round 9

**Round 10**

Q1

Q2

Q3

Q4

Q5

Q6

Q7

Q8

Q9

Q10

Answers

Bonus Round

# Round 10

## Washington, D.C.

Please mute yourselves!



# Round 10 — Washington, D.C. — Question 1

Welcome to  
Quarantine Trivia  
IX!

## Question

To within three years, in what year was the 23<sup>rd</sup> Amendment, which gave the residents of Washington, D.C., the right to vote in presidential elections, ratified?

Round 1

Round 2

Round 3

Round 4

Round 5

Round 6

Round 7

Round 8

Round 9

Round 10

Q1

Q2

Q3

Q4

Q5

Q6

Q7

Q8

Q9

Q10

Answers

Bonus Round

# Round 10 — Washington, D.C. — Question 2

Welcome to  
Quarantine Trivia  
IX!

## Question

Referring to the fact that they have no representation in Congress, what slogan is on Washington, D.C., license plates?

Round 1

Round 2

Round 3

Round 4

Round 5

Round 6

Round 7

Round 8

Round 9

Round 10

Q1

**Q2**

Q3

Q4

Q5

Q6

Q7

Q8

Q9

Q10

Answers

Bonus Round

# Round 10 — Washington, D.C. — Question 3

Welcome to  
Quarantine Trivia  
IX!

## Question

Which architect designed the Washington Monument?

Round 1

Round 2

Round 3

Round 4

Round 5

Round 6

Round 7

Round 8

Round 9

Round 10

Q1

Q2

**Q3**

Q4

Q5

Q6

Q7

Q8

Q9

Q10

Answers

Bonus Round

# Round 10 — Washington, D.C. — Question 4

Welcome to  
Quarantine Trivia  
IX!

## Question

What is the name of the park in downtown Washington, D.C., that extends from the Capitol on the east to the Lincoln Memorial on the west?

Round 1

Round 2

Round 3

Round 4

Round 5

Round 6

Round 7

Round 8

Round 9

Round 10

Q1

Q2

Q3

**Q4**

Q5

Q6

Q7

Q8

Q9

Q10

Answers

Bonus Round

# Round 10 — Washington, D.C. — Question 5

Welcome to  
Quarantine Trivia  
IX!

## Question

Which  
Washington, D.C.,  
building is  
pictured here?



Round 1

Round 2

Round 3

Round 4

Round 5

Round 6

Round 7

Round 8

Round 9

Round 10

Q1

Q2

Q3

Q4

**Q5**

Q6

Q7

Q8

Q9

Q10

Answers

Bonus Round

# Round 10 — Washington, D.C. — Question 6

Welcome to  
Quarantine Trivia  
IX!

## Question

On which river is Washington, D.C., situated?

Round 1

Round 2

Round 3

Round 4

Round 5

Round 6

Round 7

Round 8

Round 9

Round 10

Q1

Q2

Q3

Q4

Q5

**Q6**

Q7

Q8

Q9

Q10

Answers

Bonus Round

# Round 10 — Washington, D.C. — Question 7

Welcome to  
Quarantine Trivia  
IX!

## Question

What is the name of the Vice President's residence?

Round 1

Round 2

Round 3

Round 4

Round 5

Round 6

Round 7

Round 8

Round 9

Round 10

Q1

Q2

Q3

Q4

Q5

Q6

**Q7**

Q8

Q9

Q10

Answers

Bonus Round

# Round 10 — Washington, D.C. — Question 8

Welcome to  
Quarantine Trivia  
IX!

## Question

What is the name of the Washington, D.C., theatre in which Lincoln was assassinated?

Round 1

Round 2

Round 3

Round 4

Round 5

Round 6

Round 7

Round 8

Round 9

Round 10

Q1

Q2

Q3

Q4

Q5

Q6

Q7

**Q8**

Q9

Q10

Answers

Bonus Round



# Round 10 — Washington, D.C. — Question 9

Welcome to  
Quarantine Trivia  
IX!

## Question

What organization did the following saying refer to:  
“Washington — first in war, first in peace, last in the  
American League”?

Round 1

Round 2

Round 3

Round 4

Round 5

Round 6

Round 7

Round 8

Round 9

Round 10

Q1

Q2

Q3

Q4

Q5

Q6

Q7

Q8

**Q9**

Q10

Answers

Bonus Round

# Round 10 — Washington, D.C. — Question 10

Welcome to  
Quarantine Trivia  
IX!

## Question

Which monument's inscription reads, "Here rests in honored glory an American soldier known but to God"?

Round 1

Round 2

Round 3

Round 4

Round 5

Round 6

Round 7

Round 8

Round 9

Round 10

Q1

Q2

Q3

Q4

Q5

Q6

Q7

Q8

Q9

**Q10**

Answers

Bonus Round

Round 1

Round 2

Round 3

Round 4

Round 5

Round 6

Round 7

Round 8

Round 9

Round 10

Q1

Q2

Q3

Q4

Q5

Q6

Q7

Q8

Q9

Q10

Answers

Bonus Round

# Round 10

## Answers

Unmute yourselves!

# Round 10 — Washington, D.C. — Answer 1

Welcome to  
Quarantine Trivia  
IX!

## Question

To within three years, in what year was the 23<sup>rd</sup> Amendment, which gave the residents of Washington, D.C., the right to vote in presidential elections, ratified?

Round 1

Round 2

Round 3

Round 4

Round 5

Round 6

Round 7

Round 8

Round 9

Round 10

Q1

Q2

Q3

Q4

Q5

Q6

Q7

Q8

Q9

Q10

Answers

Bonus Round

# Round 10 — Washington, D.C. — Answer 1

Welcome to  
Quarantine Trivia  
IX!

## Question

To within three years, in what year was the 23<sup>rd</sup> Amendment, which gave the residents of Washington, D.C., the right to vote in presidential elections, ratified?

## Answer

1961 (1958–1964  
will be accepted)

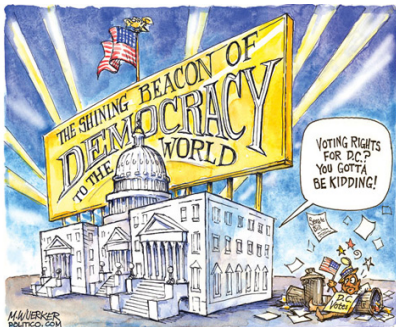

Round 1

Round 2

Round 3

Round 4

Round 5

Round 6

Round 7

Round 8

Round 9

Round 10

Q1

Q2

Q3

Q4

Q5

Q6

Q7

Q8

Q9

Q10

Answers

Bonus Round

# Round 10 — Washington, D.C. — Answer 2

Welcome to  
Quarantine Trivia  
IX!

## Question

Referring to the fact that they have no representation in Congress, what slogan is on Washington, D.C., license plates?

Round 1

Round 2

Round 3

Round 4

Round 5

Round 6

Round 7

Round 8

Round 9

Round 10

Q1

Q2

Q3

Q4

Q5

Q6

Q7

Q8

Q9

Q10

Answers

Bonus Round

## Round 10 — Washington, D.C. — Answer 2

Welcome to  
Quarantine Trivia  
IX!

### Question

Referring to the fact that they have no representation in Congress, what slogan is on Washington, D.C., license plates?

### Answer

Any answer including the phrase “taxation without representation” will be accepted



Round 1

Round 2

Round 3

Round 4

Round 5

Round 6

Round 7

Round 8

Round 9

Round 10

Q1

Q2

Q3

Q4

Q5

Q6

Q7

Q8

Q9

Q10

Answers

Bonus Round

# Round 10 — Washington, D.C. — Answer 3

Welcome to  
Quarantine Trivia  
IX!

## Question

Which architect designed the Washington Monument?

Round 1

Round 2

Round 3

Round 4

Round 5

Round 6

Round 7

Round 8

Round 9

Round 10

Q1

Q2

Q3

Q4

Q5

Q6

Q7

Q8

Q9

Q10

Answers

Bonus Round



# Round 10 — Washington, D.C. — Answer 3

Welcome to  
Quarantine Trivia  
IX!

## Question

Which architect designed the Washington Monument?

## Answer

Robert Mills

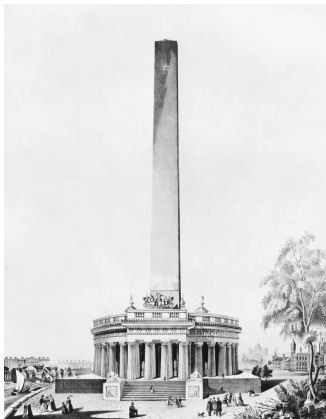

Round 1

Round 2

Round 3

Round 4

Round 5

Round 6

Round 7

Round 8

Round 9

Round 10

Q1

Q2

Q3

Q4

Q5

Q6

Q7

Q8

Q9

Q10

Answers

Bonus Round

# Round 10 — Washington, D.C. — Answer 4

Welcome to  
Quarantine Trivia  
IX!

## Question

What is the name of the park in downtown Washington, D.C., that extends from the Capitol on the east to the Lincoln Memorial on the west?

Round 1

Round 2

Round 3

Round 4

Round 5

Round 6

Round 7

Round 8

Round 9

Round 10

Q1

Q2

Q3

Q4

Q5

Q6

Q7

Q8

Q9

Q10

Answers

Bonus Round

# Round 10 — Washington, D.C. — Answer 4

Welcome to  
Quarantine Trivia  
IX!

## Question

What is the name of the park in downtown Washington, D.C., that extends from the Capitol on the east to the Lincoln Memorial on the west?

## Answer

The National Mall



Round 1

Round 2

Round 3

Round 4

Round 5

Round 6

Round 7

Round 8

Round 9

Round 10

Q1

Q2

Q3

Q4

Q5

Q6

Q7

Q8

Q9

Q10

Answers

Bonus Round

# Round 10 — Washington, D.C. — Answer 5

Welcome to  
Quarantine Trivia  
IX!

## Question

Which  
Washington, D.C.,  
building is  
pictured here?



Round 1

Round 2

Round 3

Round 4

Round 5

Round 6

Round 7

Round 8

Round 9

Round 10

Q1

Q2

Q3

Q4

Q5

Q6

Q7

Q8

Q9

Q10

Answers

Bonus Round

# Round 10 — Washington, D.C. — Answer 5

Welcome to  
Quarantine Trivia  
IX!

## Question

Which  
Washington, D.C.,  
building is  
pictured here?

## Answer

The Library of  
Congress



Round 1

Round 2

Round 3

Round 4

Round 5

Round 6

Round 7

Round 8

Round 9

Round 10

Q1

Q2

Q3

Q4

Q5

Q6

Q7

Q8

Q9

Q10

Answers

Bonus Round

# Round 10 — Washington, D.C. — Answer 6

Welcome to  
Quarantine Trivia  
IX!

## Question

On which river is Washington, D.C., situated?

Round 1

Round 2

Round 3

Round 4

Round 5

Round 6

Round 7

Round 8

Round 9

Round 10

Q1

Q2

Q3

Q4

Q5

Q6

Q7

Q8

Q9

Q10

Answers

Bonus Round

# Round 10 — Washington, D.C. — Answer 6

Welcome to  
Quarantine Trivia  
IX!

## Question

On which river is Washington, D.C., situated?

## Answer

The Potomac River



Round 1

Round 2

Round 3

Round 4

Round 5

Round 6

Round 7

Round 8

Round 9

Round 10

Q1

Q2

Q3

Q4

Q5

Q6

Q7

Q8

Q9

Q10

Answers

Bonus Round

# Round 10 — Washington, D.C. — Answer 7

Welcome to  
Quarantine Trivia  
IX!

## Question

What is the name of the Vice President's residence?

Round 1

Round 2

Round 3

Round 4

Round 5

Round 6

Round 7

Round 8

Round 9

Round 10

Q1

Q2

Q3

Q4

Q5

Q6

Q7

Q8

Q9

Q10

Answers

Bonus Round



# Round 10 — Washington, D.C. — Answer 7

Welcome to  
Quarantine Trivia  
IX!

## Question

What is the name of the Vice President's residence?

## Answer

Number One  
Observatory Circle  
/ Admiral's House  
/ Naval  
Observatory



Round 1

Round 2

Round 3

Round 4

Round 5

Round 6

Round 7

Round 8

Round 9

Round 10

Q1

Q2

Q3

Q4

Q5

Q6

Q7

Q8

Q9

Q10

Answers

Bonus Round

# Round 10 — Washington, D.C. — Answer 8

Welcome to  
Quarantine Trivia  
IX!

## Question

What is the name of the Washington, D.C., theatre in which Lincoln was assassinated?

Round 1

Round 2

Round 3

Round 4

Round 5

Round 6

Round 7

Round 8

Round 9

Round 10

Q1

Q2

Q3

Q4

Q5

Q6

Q7

Q8

Q9

Q10

Answers

Bonus Round

# Round 10 — Washington, D.C. — Answer 8

Welcome to  
Quarantine Trivia  
IX!

## Question

What is the name of the Washington, D.C., theatre in which Lincoln was assassinated?

## Answer

Ford's Theatre



Round 1

Round 2

Round 3

Round 4

Round 5

Round 6

Round 7

Round 8

Round 9

Round 10

Q1

Q2

Q3

Q4

Q5

Q6

Q7

Q8

Q9

Q10

Answers

Bonus Round

# Round 10 — Washington, D.C. — Answer 9

Welcome to  
Quarantine Trivia  
IX!

## Question

What organization did the following saying refer to:  
“Washington — first in war, first in peace, last in the  
American League”?

Round 1

Round 2

Round 3

Round 4

Round 5

Round 6

Round 7

Round 8

Round 9

Round 10

Q1

Q2

Q3

Q4

Q5

Q6

Q7

Q8

Q9

Q10

Answers

Bonus Round

# Round 10 — Washington, D.C. — Answer 9

Welcome to  
Quarantine Trivia  
IX!

## Question

What organization did the following saying refer to:  
“Washington — first in war, first in peace, last in the  
American League”?

## Answer

The Washington  
Senators



Round 1

Round 2

Round 3

Round 4

Round 5

Round 6

Round 7

Round 8

Round 9

Round 10

Q1

Q2

Q3

Q4

Q5

Q6

Q7

Q8

Q9

Q10

Answers

Bonus Round

# Round 10 — Washington, D.C. — Answer 10

Welcome to  
Quarantine Trivia  
IX!

## Question

Which monument's inscription reads, "Here rests in honored glory an American soldier known but to God"?

Round 1

Round 2

Round 3

Round 4

Round 5

Round 6

Round 7

Round 8

Round 9

Round 10

Q1

Q2

Q3

Q4

Q5

Q6

Q7

Q8

Q9

Q10

Answers

Bonus Round

# Round 10 — Washington, D.C. — Answer 10

Welcome to  
Quarantine Trivia  
IX!

## Question

Which monument's inscription reads, "Here rests in honored glory an American soldier known but to God"?

## Answer

The Tomb of the  
Unknown Soldier  
/ Tomb of the  
Unknowns



Round 1

Round 2

Round 3

Round 4

Round 5

Round 6

Round 7

Round 8

Round 9

Round 10

Q1

Q2

Q3

Q4

Q5

Q6

Q7

Q8

Q9

Q10

Answers

Bonus Round

Round 1

Round 2

Round 3

Round 4

Round 5

Round 6

Round 7

Round 8

Round 9

Round 10

**Bonus Round**

Q1

Q2

Q3

Q4

Q5

Q6

Q7

Q8

Q9

Q10

Answers

## Bonus Round

Please mute yourselves!

Get ready for some *devilishly* hard questions!





# Bonus Round — Aviation

Welcome to  
Quarantine Trivia  
IX!

## Question

What was the make and model of the plane that Chesley “Sully” Sullenberger crash landed in the Hudson after colliding with a flock of geese?

Round 1

Round 2

Round 3

Round 4

Round 5

Round 6

Round 7

Round 8

Round 9

Round 10

Bonus Round

Q1

Q2

Q3

Q4

Q5

Q6

Q7

Q8

Q9

Q10

Answers

# Bonus Round — Ireland

Welcome to  
Quarantine Trivia  
IX!

## Question

What is the name of the Irish playwright who wrote “The Playboy of the Western World?”

Round 1

Round 2

Round 3

Round 4

Round 5

Round 6

Round 7

Round 8

Round 9

Round 10

Bonus Round

Q1

**Q2**

Q3

Q4

Q5

Q6

Q7

Q8

Q9

Q10

Answers

# Bonus Round — Colonial America

Welcome to  
Quarantine Trivia  
IX!

## Question

Which of the original thirteen colonies was the last to be established?

Round 1

Round 2

Round 3

Round 4

Round 5

Round 6

Round 7

Round 8

Round 9

Round 10

Bonus Round

Q1

Q2

**Q3**

Q4

Q5

Q6

Q7

Q8

Q9

Q10

Answers

# Bonus Round — Famous Ships and Boats

Welcome to  
Quarantine Trivia  
IX!

## Question

What is name of the ship that wrecked with Gulliver aboard and from which he swam to Lilliput?

Round 1

Round 2

Round 3

Round 4

Round 5

Round 6

Round 7

Round 8

Round 9

Round 10

Bonus Round

Q1

Q2

Q3

**Q4**

Q5

Q6

Q7

Q8

Q9

Q10

Answers

# Bonus Round — Foreign Words and Phrases

Welcome to  
Quarantine Trivia  
IX!

## Question

Roman-à-clef

Round 1

Round 2

Round 3

Round 4

Round 5

Round 6

Round 7

Round 8

Round 9

Round 10

Bonus Round

Q1

Q2

Q3

Q4

**Q5**

Q6

Q7

Q8

Q9

Q10

Answers

# Bonus Round — Birds

Welcome to  
Quarantine Trivia  
IX!

## Question

Which species of bird has (by far) the longest annual migration?

Round 1

Round 2

Round 3

Round 4

Round 5

Round 6

Round 7

Round 8

Round 9

Round 10

Bonus Round

Q1

Q2

Q3

Q4

Q5

**Q6**

Q7

Q8

Q9

Q10

Answers

# Bonus Round — Native Americans

Welcome to  
Quarantine Trivia  
IX!

## Question

What are the names of the five tribes that make up the Iroquois Confederacy? (We need all five.)

Round 1

Round 2

Round 3

Round 4

Round 5

Round 6

Round 7

Round 8

Round 9

Round 10

Bonus Round

Q1

Q2

Q3

Q4

Q5

Q6

**Q7**

Q8

Q9

Q10

Answers

# Bonus Round — The home of ...

Welcome to  
Quarantine Trivia  
IX!

## Question

The USA, according to George M. Cohan in his song  
“You’re a Grand Old Flag.”

Round 1

Round 2

Round 3

Round 4

Round 5

Round 6

Round 7

Round 8

Round 9

Round 10

Bonus Round

Q1

Q2

Q3

Q4

Q5

Q6

Q7

**Q8**

Q9

Q10

Answers



# Bonus Round — Wonders of Engineering

Welcome to  
Quarantine Trivia  
IX!

## Question

In 1994, the American Society of Civil Engineers compiled a list of Seven Wonders of the Modern World, the greatest civil engineering achievements of the 20<sup>th</sup> century. Name three of these seven Wonders.

Round 1

Round 2

Round 3

Round 4

Round 5

Round 6

Round 7

Round 8

Round 9

Round 10

Bonus Round

Q1

Q2

Q3

Q4

Q5

Q6

Q7

Q8

**Q9**

Q10

Answers

# Bonus Round — Washington, D.C.

Welcome to  
Quarantine Trivia  
IX!

## Question

Who designed the street plan of Washington, D.C.?

Round 1

Round 2

Round 3

Round 4

Round 5

Round 6

Round 7

Round 8

Round 9

Round 10

Bonus Round

Q1

Q2

Q3

Q4

Q5

Q6

Q7

Q8

Q9

**Q10**

Answers

Round 1

Round 2

Round 3

Round 4

Round 5

Round 6

Round 7

Round 8

Round 9

Round 10

Bonus Round

Q1

Q2

Q3

Q4

Q5

Q6

Q7

Q8

Q9

Q10

Answers

## Bonus Round Answers

Unmute yourselves!

# Bonus Round — Aviation

Welcome to  
Quarantine Trivia  
IX!

## Question

What was the make and model of the plane that Chesley “Sully” Sullenberger crash landed in the Hudson after colliding with a flock of geese?

Round 1

Round 2

Round 3

Round 4

Round 5

Round 6

Round 7

Round 8

Round 9

Round 10

Bonus Round

Q1

Q2

Q3

Q4

Q5

Q6

Q7

Q8

Q9

Q10

Answers

# Bonus Round — Aviation

Welcome to  
Quarantine Trivia  
IX!

## Question

What was the make and model of the plane that Chesley “Sully” Sullenberger crash landed in the Hudson after colliding with a flock of geese?

## Answer

Airbus A320



Round 1

Round 2

Round 3

Round 4

Round 5

Round 6

Round 7

Round 8

Round 9

Round 10

Bonus Round

Q1

Q2

Q3

Q4

Q5

Q6

Q7

Q8

Q9

Q10

Answers

# Bonus Round — Ireland

Welcome to  
Quarantine Trivia  
IX!

## Question

What is the name of the Irish playwright who wrote “The Playboy of the Western World?”

Round 1

Round 2

Round 3

Round 4

Round 5

Round 6

Round 7

Round 8

Round 9

Round 10

Bonus Round

Q1

Q2

Q3

Q4

Q5

Q6

Q7

Q8

Q9

Q10

Answers

# Bonus Round — Ireland

Welcome to  
Quarantine Trivia  
IX!

## Question

What is the name of the Irish playwright who wrote “The Playboy of the Western World?”

## Answer

John Millington  
Synge

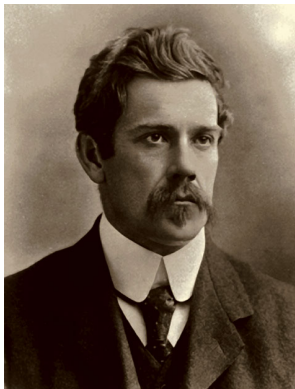

Round 1

Round 2

Round 3

Round 4

Round 5

Round 6

Round 7

Round 8

Round 9

Round 10

Bonus Round

Q1

Q2

Q3

Q4

Q5

Q6

Q7

Q8

Q9

Q10

Answers

# Bonus Round — Colonial America

Welcome to  
Quarantine Trivia  
IX!

## Question

Which of the original thirteen colonies was the last to be established?

Round 1

Round 2

Round 3

Round 4

Round 5

Round 6

Round 7

Round 8

Round 9

Round 10

Bonus Round

Q1

Q2

Q3

Q4

Q5

Q6

Q7

Q8

Q9

Q10

Answers



# Bonus Round — Colonial America

## Question

Which of the original thirteen colonies was the last to be established?

## Answer

Georgia (in 1732)



Round 1

Round 2

Round 3

Round 4

Round 5

Round 6

Round 7

Round 8

Round 9

Round 10

Bonus Round

Q1

Q2

Q3

Q4

Q5

Q6

Q7

Q8

Q9

Q10

Answers

# Bonus Round — Famous Ships and Boats

Welcome to  
Quarantine Trivia  
IX!

## Question

What is name of the ship that wrecked with Gulliver aboard and from which he swam to Lilliput?

Round 1

Round 2

Round 3

Round 4

Round 5

Round 6

Round 7

Round 8

Round 9

Round 10

Bonus Round

Q1

Q2

Q3

Q4

Q5

Q6

Q7

Q8

Q9

Q10

Answers

# Bonus Round — Famous Ships and Boats

Welcome to  
Quarantine Trivia  
IX!

## Question

What is name of the ship that wrecked with Gulliver aboard and from which he swam to Lilliput?

## Answer

The Antelope



Round 1

Round 2

Round 3

Round 4

Round 5

Round 6

Round 7

Round 8

Round 9

Round 10

Bonus Round

Q1

Q2

Q3

Q4

Q5

Q6

Q7

Q8

Q9

Q10

Answers

# Bonus Round — Foreign Words and Phrases

Welcome to  
Quarantine Trivia  
IX!

## Question

Roman-à-clef

Round 1

Round 2

Round 3

Round 4

Round 5

Round 6

Round 7

Round 8

Round 9

Round 10

Bonus Round

Q1

Q2

Q3

Q4

Q5

Q6

Q7

Q8

Q9

Q10

Answers

# Bonus Round — Foreign Words and Phrases

Welcome to  
Quarantine Trivia  
IX!

## Question

Roman-à-clef

## Answer

A novel in which  
real people and  
events appear  
with invented  
names



Round 1

Round 2

Round 3

Round 4

Round 5

Round 6

Round 7

Round 8

Round 9

Round 10

Bonus Round

Q1

Q2

Q3

Q4

Q5

Q6

Q7

Q8

Q9

Q10

Answers

# Bonus Round — Birds

Welcome to  
Quarantine Trivia  
IX!

## Question

Which species of bird has (by far) the longest annual migration?

Round 1

Round 2

Round 3

Round 4

Round 5

Round 6

Round 7

Round 8

Round 9

Round 10

Bonus Round

Q1

Q2

Q3

Q4

Q5

Q6

Q7

Q8

Q9

Q10

Answers

# Bonus Round — Birds

Welcome to  
Quarantine Trivia  
IX!

## Question

Which species of bird has (by far) the longest annual migration?

## Answer

The Arctic tern  
(from the Arctic to  
the Antarctic)

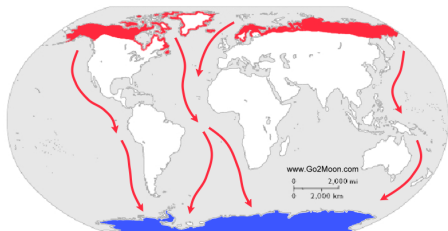

Round 1

Round 2

Round 3

Round 4

Round 5

Round 6

Round 7

Round 8

Round 9

Round 10

Bonus Round

Q1

Q2

Q3

Q4

Q5

Q6

Q7

Q8

Q9

Q10

Answers

# Bonus Round — Native Americans

Welcome to  
Quarantine Trivia  
IX!

## Question

What are the names of the five tribes that make up the Iroquois Confederacy? (We need all five.)

Round 1

Round 2

Round 3

Round 4

Round 5

Round 6

Round 7

Round 8

Round 9

Round 10

Bonus Round

Q1

Q2

Q3

Q4

Q5

Q6

Q7

Q8

Q9

Q10

Answers



# Bonus Round — Native Americans

Welcome to  
Quarantine Trivia  
IX!

## Question

What are the names of the five tribes that make up the Iroquois Confederacy? (We need all five.)

## Answer

Mohawk,  
Onondaga,  
Oneida, Cayuga  
and Seneca



Round 1

Round 2

Round 3

Round 4

Round 5

Round 6

Round 7

Round 8

Round 9

Round 10

Bonus Round

Q1

Q2

Q3

Q4

Q5

Q6

Q7

Q8

Q9

Q10

Answers

# Bonus Round — The home of ...

Welcome to  
Quarantine Trivia  
IX!

## Question

The USA, according to George M. Cohan in his song  
“You’re a Grand Old Flag.”

Round 1

Round 2

Round 3

Round 4

Round 5

Round 6

Round 7

Round 8

Round 9

Round 10

Bonus Round

Q1

Q2

Q3

Q4

Q5

Q6

Q7

Q8

Q9

Q10

Answers

# Bonus Round — The home of ...

Welcome to  
Quarantine Trivia  
IX!

## Question

The USA, according to George M. Cohan in his song  
“You’re a Grand Old Flag.”

## Answer

“The free and the  
brave”



*“You’re the emblem of the  
land I love, The home of  
the free and the brave.”*

**George M. Cohan**

Round 1

Round 2

Round 3

Round 4

Round 5

Round 6

Round 7

Round 8

Round 9

Round 10

Bonus Round

Q1

Q2

Q3

Q4

Q5

Q6

Q7

Q8

Q9

Q10

Answers

# Bonus Round — Wonders of Engineering

Welcome to  
Quarantine Trivia  
IX!

## Question

In 1994, the American Society of Civil Engineers compiled a list of Seven Wonders of the Modern World, the greatest civil engineering achievements of the 20<sup>th</sup> century. Name three of these seven Wonders.

Round 1

Round 2

Round 3

Round 4

Round 5

Round 6

Round 7

Round 8

Round 9

Round 10

Bonus Round

Q1

Q2

Q3

Q4

Q5

Q6

Q7

Q8

Q9

Q10

Answers

# Bonus Round — Wonders of Engineering

Welcome to  
Quarantine Trivia  
IX!

## Question

In 1994, the American Society of Civil Engineers compiled a list of Seven Wonders of the Modern World, the greatest civil engineering achievements of the 20<sup>th</sup> century. Name three of these seven Wonders.

## Answer

Any three of these: Channel Tunnel / Chunnel; CN Tower; Empire State Building; Golden Gate Bridge; Itaipú Dam; North Sea Protection Works / Delta Works / Zuiderzee Works; Panama Canal

Round 1

Round 2

Round 3

Round 4

Round 5

Round 6

Round 7

Round 8

Round 9

Round 10

Bonus Round

Q1

Q2

Q3

Q4

Q5

Q6

Q7

Q8

Q9

Q10

Answers

# Bonus Round — Washington, D.C.

Welcome to  
Quarantine Trivia  
IX!

## Question

Who designed the street plan of Washington, D.C.?

Round 1

Round 2

Round 3

Round 4

Round 5

Round 6

Round 7

Round 8

Round 9

Round 10

Bonus Round

Q1

Q2

Q3

Q4

Q5

Q6

Q7

Q8

Q9

Q10

Answers

# Bonus Round — Washington, D.C.

Welcome to  
Quarantine Trivia  
IX!

## Question

Who designed the street plan of Washington, D.C.?

## Answer

Pierre Charles  
L'Enfant



Round 1

Round 2

Round 3

Round 4

Round 5

Round 6

Round 7

Round 8

Round 9

Round 10

Bonus Round

Q1

Q2

Q3

Q4

Q5

Q6

Q7

Q8

Q9

Q10

Answers

Round 1

Round 2

Round 3

Round 4

Round 5

Round 6

Round 7

Round 8

Round 9

Round 10

Bonus Round

Thanks for playing!